



## LIMELIGHT PAR S

Photometric &  
Chromaticity Test Reports



# CONTENTS

Testing Procedures.....	4
Photometric Output Reports .....	
<b>Narrow Zoom Angle .....</b>	<b>5</b>
Full Output .....	5
2400K .....	7
3200K.....	9
4500K.....	11
5600K.....	13
6500K.....	15
8500K.....	17
<b>50% Zoom Angle .....</b>	<b>19</b>
Full Output .....	19
2400K .....	21
3200K.....	23
4500K.....	25
5600K.....	27
6500K.....	29
8500K.....	31
<b>Wide Zoom Angle.....</b>	<b>33</b>
Full Output .....	33
2400K .....	35
3200K.....	37
4500K.....	39
5600K.....	41
6500K.....	43
8500K.....	45

<b>Color Quality Reports .....</b>	<b>47</b>
<b>Full Output .....</b>	<b>47</b>
<b>2400K .....</b>	<b>49</b>
<b>3200K .....</b>	<b>51</b>
<b>4500K .....</b>	<b>53</b>
<b>5600K .....</b>	<b>55</b>
<b>6500K .....</b>	<b>57</b>
<b>8500K .....</b>	<b>59</b>
<b>LED Color Information Reports .....</b>	<b>61</b>
<b>RED .....</b>	<b>61</b>
<b>GREEN .....</b>	<b>62</b>
<b>BLUE .....</b>	<b>63</b>
<b>LIME .....</b>	<b>64</b>

©2023 **ELATION PROFESSIONAL** all rights reserved. Information, specifications, diagrams, images, and instructions herein are subject to change without notice. ELATION PROFESSIONAL logo and identifying product names and numbers herein are trademarks of ELATION PROFESSIONAL. Copyright protection claimed includes all forms and matters of copyrightable materials and information now allowed by statutory or judicial law or hereinafter granted. Product names used in this document may be trademarks or registered trademarks of their respective companies and are hereby acknowledged. All non-ELATION brands and product names are trademarks or registered trademarks of their respective companies.

**Elation Professional USA** | 6122 S. Eastern Ave. | Los Angeles, CA. 90040  
323-582-3322 | 323-832-9142 fax | [www.elationlighting.com](http://www.elationlighting.com) | [info@elationlighting.com](mailto:info@elationlighting.com)

**Elation Professional B.V.** | Junostraat 2 | 6468 EW Kerkrade, The Netherlands  
+31 45 546 85 66 | +31 45 546 85 96 fax | [www.elationlighting.eu](http://www.elationlighting.eu) | [info@elationlighting.eu](mailto:info@elationlighting.eu)

**Elation Professional Mexico** | AV Santa Ana 30 | Parque Industrial Lerma, Lerma, Mexico 52000

+52 (728) 282-7070

# Testing Process

## Total Lumen Measurements

Lumens are measured using a Viso Systems Lab Spion. As a goniophotometer, the Viso calculates the field lumens of the fixture by taking multiple measurements across the light beam.

Many lumens figures provided for entertainment lighting fixtures are only  $2\pi$  sphere values, some even emphasize the LED engine lumens. All Elation product photometric data is the actual light output from the fixture lens, never a theoretical value based on calculation or using the source lumens as the fixtures output. We advise to always compare total fixture lumens acquired with identical measurement systems when comparing lighting fixtures.

## Test Lab Equipment and Process

Elation operates an optical testing laboratory at its Los Angeles, CA headquarters to provide accurate photometric data for its lighting products. The testing lab is both light and climate- controlled and contains a variety of precise lighting measurement systems. Fixtures are analyzed with the sophisticated [Viso Systems Lab Spion](#) equipment, which measures all light and color parameters by panning the light beam at a precise speed and from different angles through a calibrated, laser aligned light and color sensor. Test data is collected and summarized by the Viso Light Inspector software. This type of measurement system is referred to as a Goniophotometer.

The Viso software calculates all relevant types of measurements, from beam angles, candela to center light intensity at a variety of distances to the latest color quality measurements like TM30 or CQS as well as accurate color temperature. This wealth of data is then processed by an Elation specific template which is included in the photometric test report for various fixture conditions such as zoom angles and color correction filters.

The Viso software also creates IES (Illuminating Engineering Society) files for each test report. IES is an industry standard file format created for the easy electronic transfer of photometric test data, which is widely used by lighting manufacturers for photometric data distribution.

Additionally, fixtures are periodically rechecked for accuracy using various hand-held light meters including one or more of the devices listed below. This is done to ensure the test data contained in this report is as accurate as possible.

[Asenstek Lighting Passport](#) | [Konica Minolta T-10](#) | [Sekonic C800U](#)

### Key Measurements

#### Output

Total Lumen Output: 1707 lm  
Peak Intensity: 203440 cd

#### Beam

Beam Angle (50%): 5.3°  
Field Angle (10%): 8°  
Cutoff Angle (2.5%): 10.1°

#### Color

Color Temperature: 0 K  
CRI: 0.0  
TLCI: n/a  
TM30 R<sub>F</sub>: 0.0  
TM30 R<sub>g</sub>: 0.0

#### Power Details

Efficacy: 7 Lumen/Watt  
Power: 232.2 W  
Supply Voltage: 119 V  
Current: 1.96 A

### Beam Details

Distance	3 m	5 m	10 m	15 m	20 m
Beam Width	0.3 m	0.5 m	0.9 m	1.4 m	1.8 m

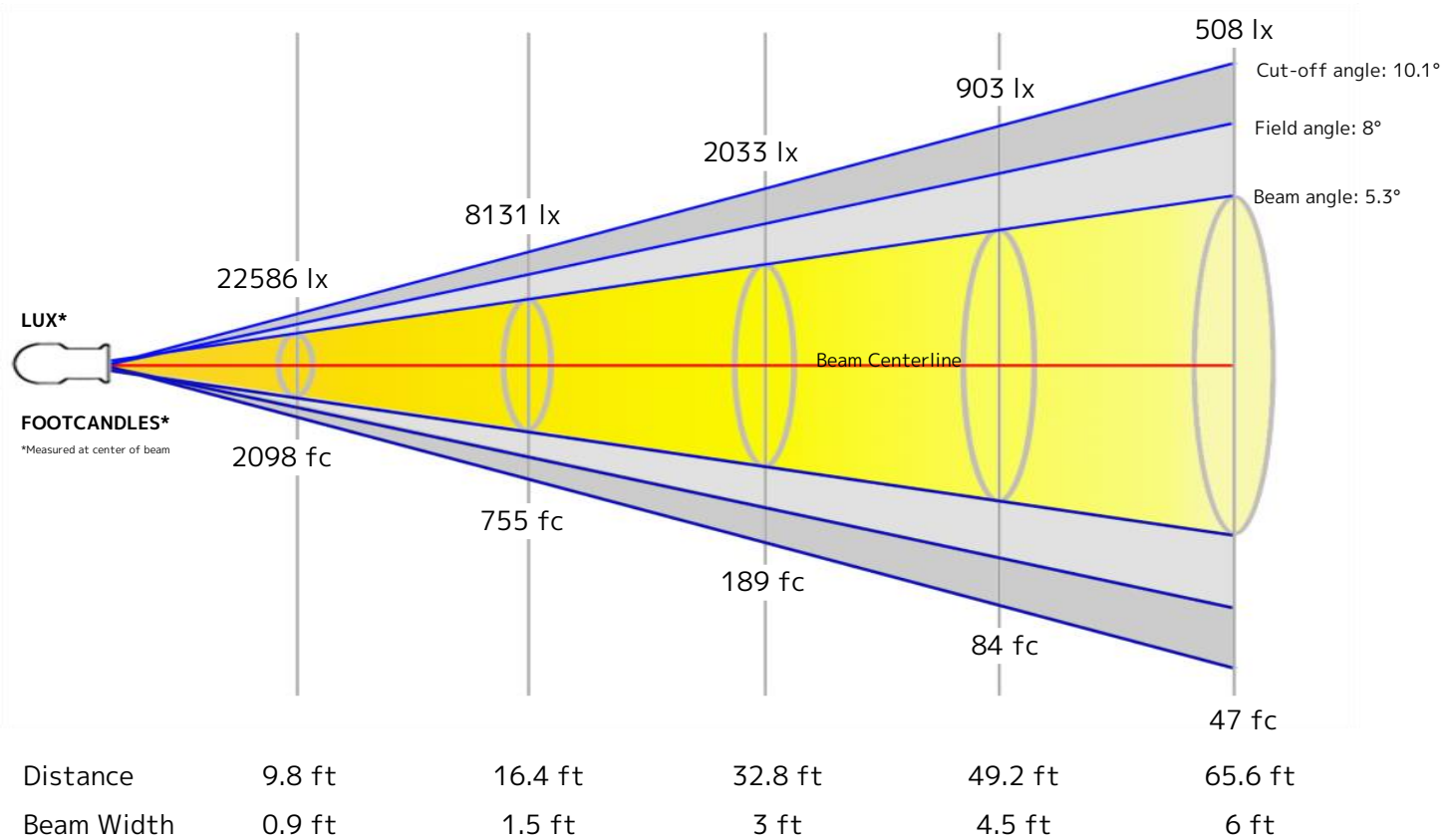

### Beam Intensities from 1-20m

M	1	2	3	4	5	6	7	8	9	10	11	12	13	14	15	16	17	18	19	20
<b>LX</b>	203274	50818	22586	12705	8131	5646	4148	3176	2510	2033	1680	1412	1203	1037	903	794	703	627	563	508
<b>FT</b>	3.3	6.6	9.8	13.1	16.4	19.7	23	26.2	29.5	32.8	36.1	39.4	42.7	45.9	49.2	52.5	55.8	59.1	62.3	65.6
<b>FC</b>	18884.7	4721.2	2098.3	1180.3	755.4	524.6	385.4	295.1	233.1	188.8	156.1	131.1	111.7	96.4	83.9	73.8	65.3	58.3	52.3	47.2

## Angular Distribution

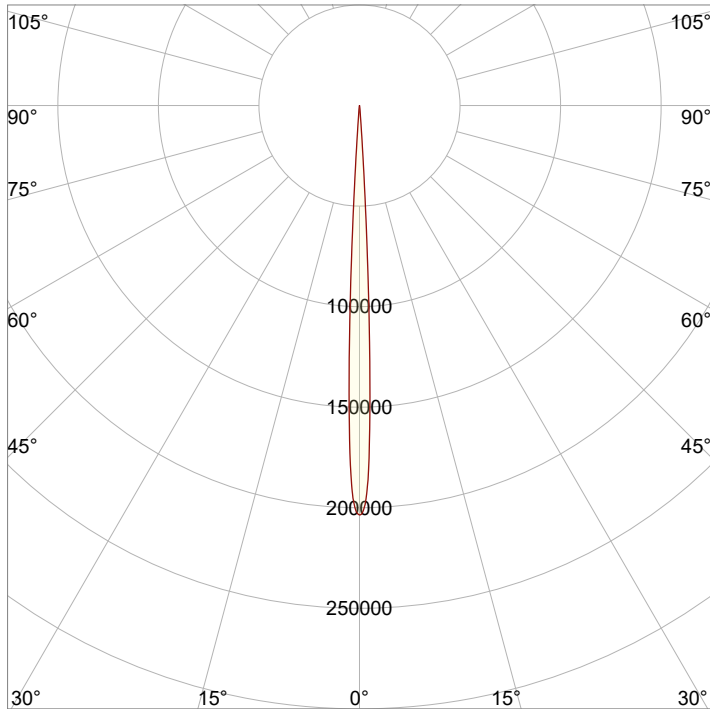

<b>Beam Angle - 50%</b>
<b>5.3°</b>
<b>Field Angle - 10%</b>
<b>8°</b>
<b>Cutoff Angle - 2.5%</b>
<b>10.1°</b>

## ISO Diagrams

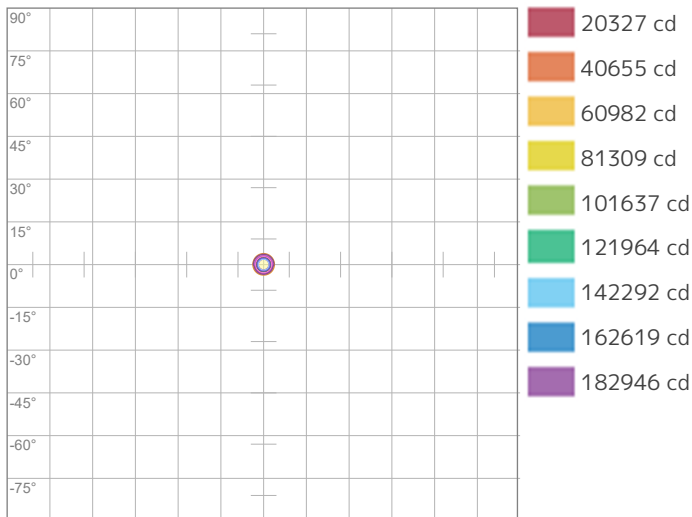

ISO Candela Diagram

Conditions:

Number of c-planes: 2

Candela at center: 203274 cd

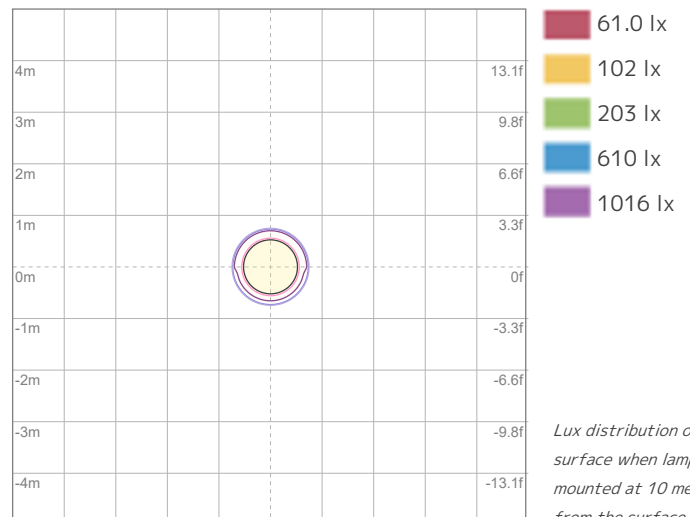

ISO LUX Diagram

Conditions:

Number of c-planes: 2

LUX at center: 2033 lx

*Lux distribution on a surface when lamp is mounted at 10 meters from the surface.*

## Linear Distribution

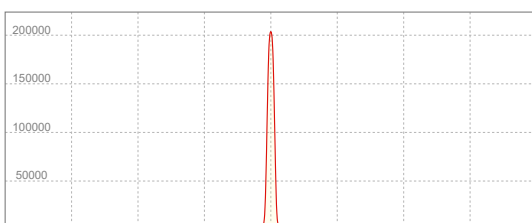

**Peak Candela**  
**203440 cd**

**Calculate Center Beam Intensities**

$$\text{lux} = 203440 / \text{distance(m)}^2$$

$$\text{fc} = 203440 / \text{distance(ft)}^2$$

### Key Measurements

#### Output

Total Lumen Output: 1681 lm  
Peak Intensity: 200500 cd

#### Beam

Beam Angle (50%): 5.3°  
Field Angle (10%): 8.3°  
Cutoff Angle (2.5%): 10.2°

#### Color

Color Temperature: 2323 K  
CRI: 78.6  
TLCI: 56  
TM30 R<sub>F</sub>: 81.0  
TM30 R<sub>G</sub>: 115.8

#### Power Details

Efficacy: 8 Lumen/Watt  
Power: 210 W  
Supply Voltage: 120 V  
Current: 1.77 A

### Beam Details

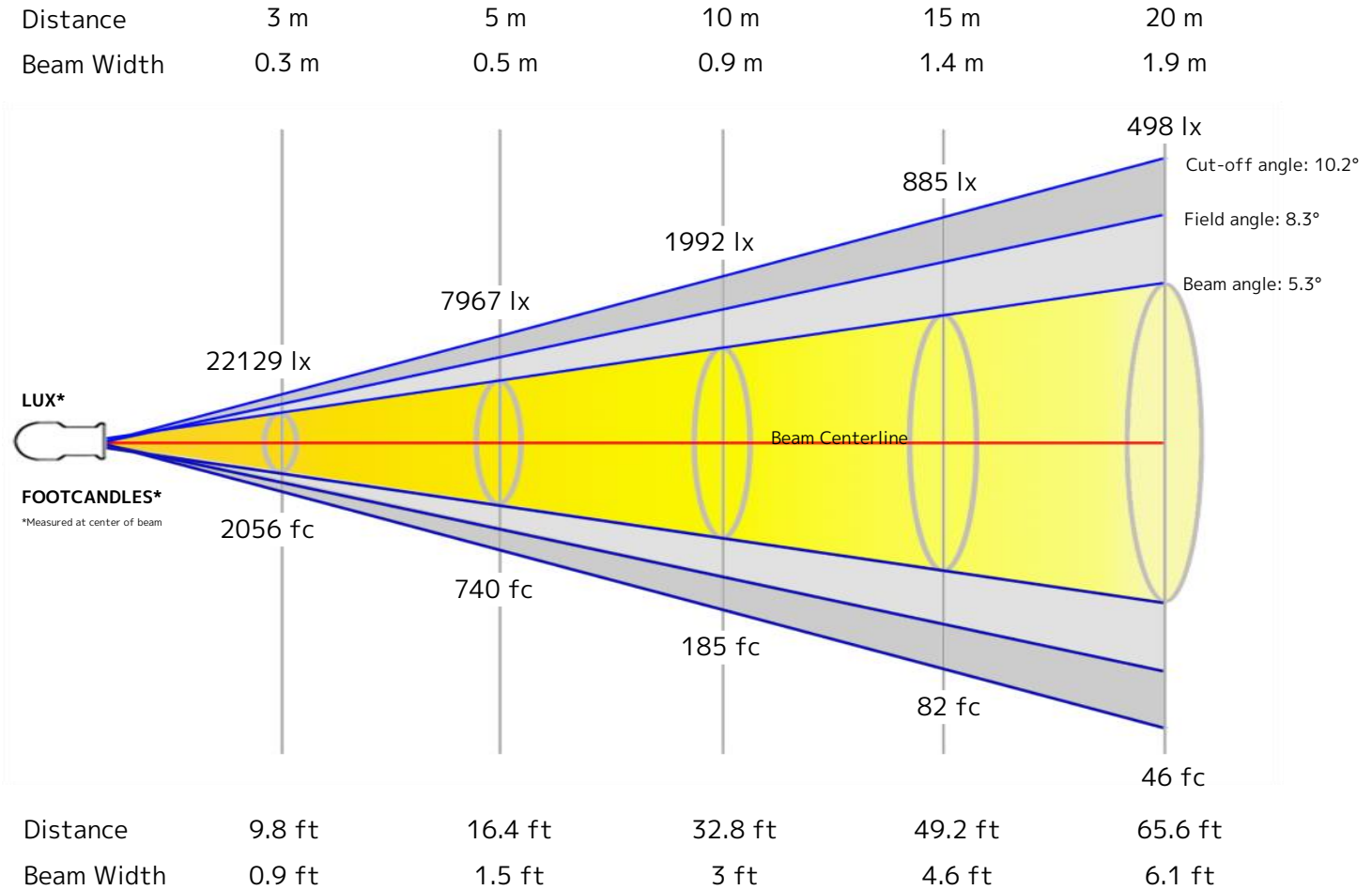

### Beam Intensities from 1-20m

M	1	2	3	4	5	6	7	8	9	10	11	12	13	14	15	16	17	18	19	20
<b>LX</b>	199163	49791	22129	12448	7967	5532	4065	3112	2459	1992	1646	1383	1178	1016	885	778	689	615	552	498
<b>FT</b>	3.3	6.6	9.8	13.1	16.4	19.7	23	26.2	29.5	32.8	36.1	39.4	42.7	45.9	49.2	52.5	55.8	59.1	62.3	65.6
<b>FC</b>	18502.9	4625.7	2055.9	1156.4	740.1	514	377.6	289.1	228.4	185	152.9	128.5	109.5	94.4	82.2	72.3	64	57.1	51.3	46.3

### Angular Distribution

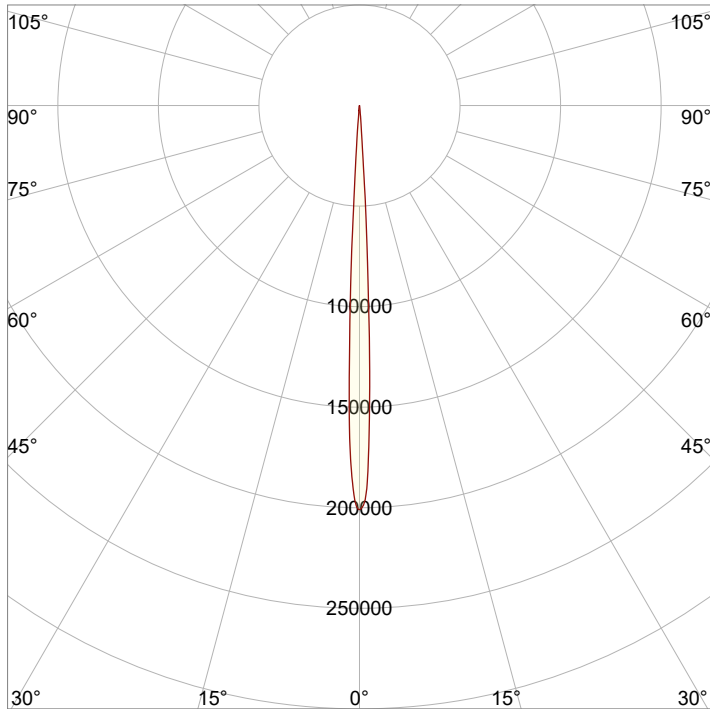

<b>Beam Angle - 50%</b>
<b>5.3°</b>
<b>Field Angle - 10%</b>
<b>8.3°</b>
<b>Cutoff Angle - 2.5%</b>
<b>10.2°</b>

### ISO Diagrams

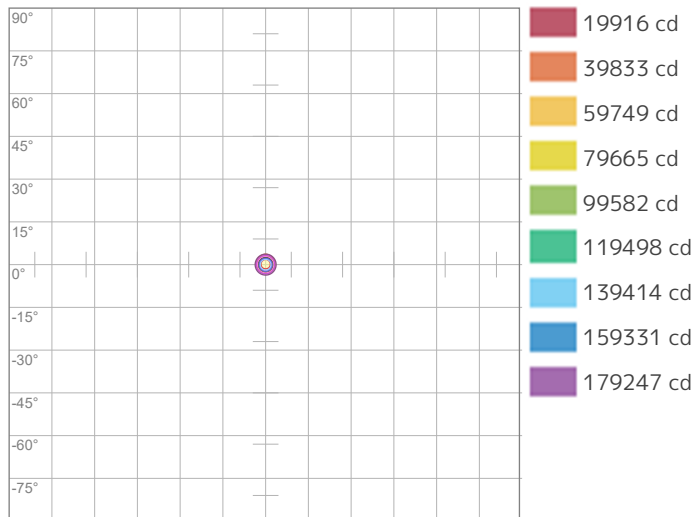

ISO Candela Diagram

Conditions:

Number of c-planes: 2

Candela at center: 199163 cd

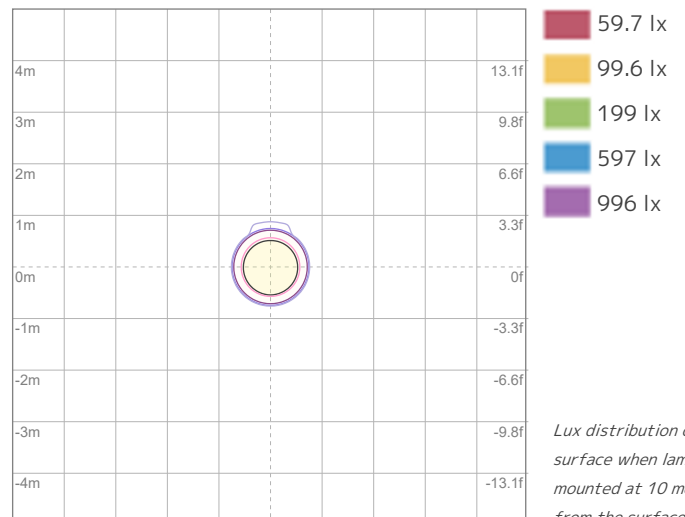

ISO LUX Diagram

Conditions:

Number of c-planes: 2

LUX at center: 1992 lx

*Lux distribution on a surface when lamp is mounted at 10 meters from the surface.*

### Linear Distribution

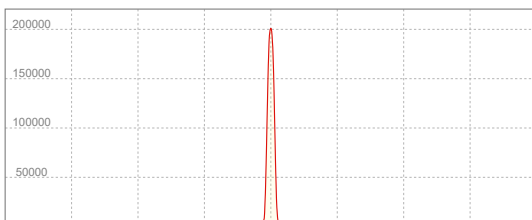

**Peak Candela**  
**200500 cd**

**Calculate Center Beam Intensities**

$$\text{lux} = 200500 / \text{distance(m)}^2$$

$$\text{fc} = 200500 / \text{distance(ft)}^2$$

### Key Measurements

#### Output

Total Lumen Output: 1775 lm  
Peak Intensity: 216535 cd

#### Beam

Beam Angle (50%): 5.3°  
Field Angle (10%): 7.9°  
Cutoff Angle (2.5%): 9.6°

#### Color

Color Temperature: 3173 K  
CRI: 82.8  
TLCI: 73  
TM30 R<sub>F</sub>: 84.4  
TM30 R<sub>g</sub>: 103.1

#### Power Details

Efficacy: 10 Lumen/Watt  
Power: 175.1 W  
Supply Voltage: 119 V  
Current: 1.49 A

### Beam Details

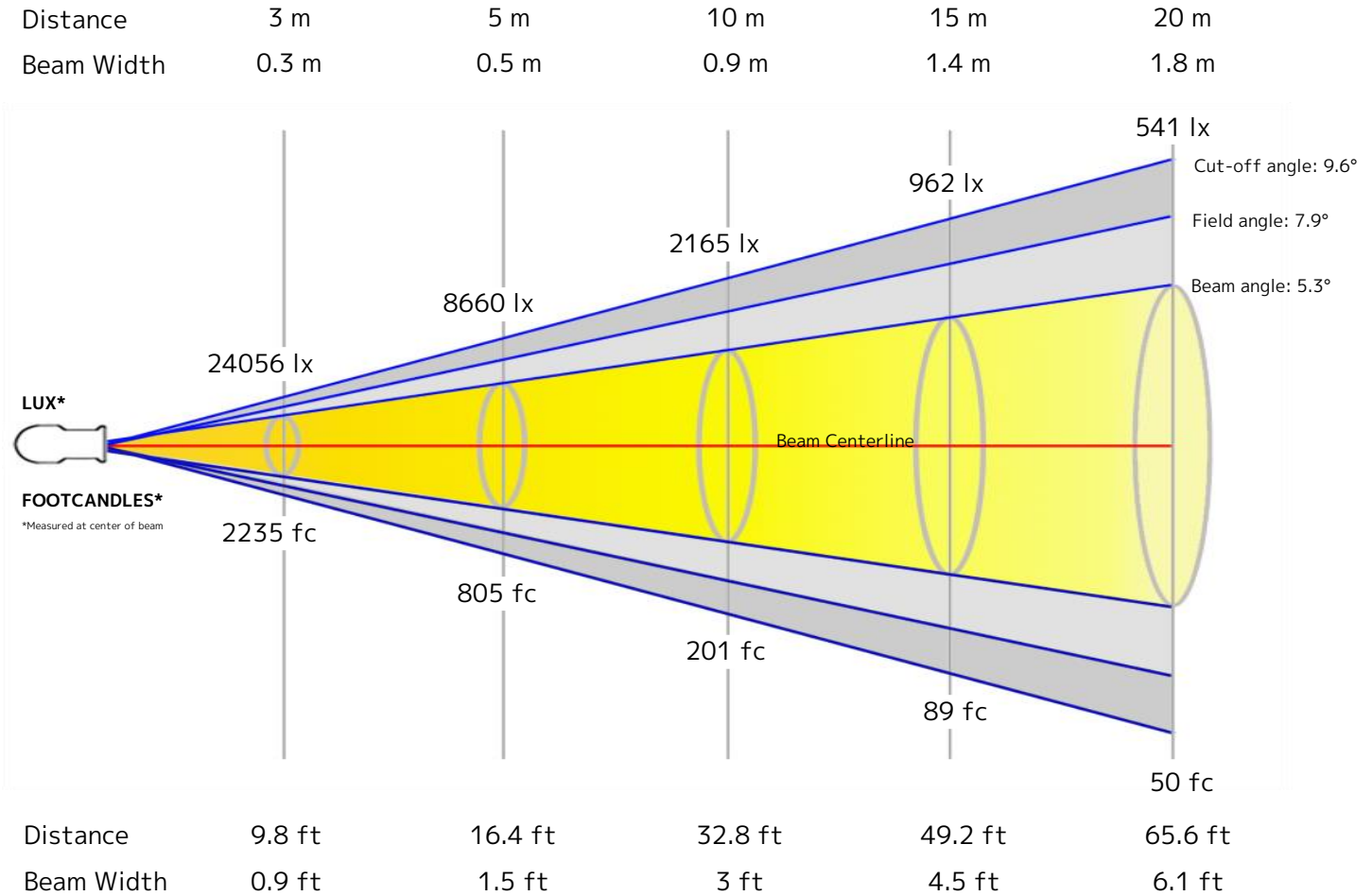

### Beam Intensities from 1-20m

M	1	2	3	4	5	6	7	8	9	10	11	12	13	14	15	16	17	18	19	20
<b>LX</b>	216502	54126	24056	13531	8660	6014	4418	3383	2673	2165	1789	1503	1281	1105	962	846	749	668	600	541
<b>FT</b>	3.3	6.6	9.8	13.1	16.4	19.7	23	26.2	29.5	32.8	36.1	39.4	42.7	45.9	49.2	52.5	55.8	59.1	62.3	65.6
<b>FC</b>	20113.7	5028.4	2234.9	1257.1	804.5	558.7	410.5	314.3	248.3	201.1	166.2	139.7	119	102.6	89.4	78.6	69.6	62.1	55.7	50.3

### Angular Distribution

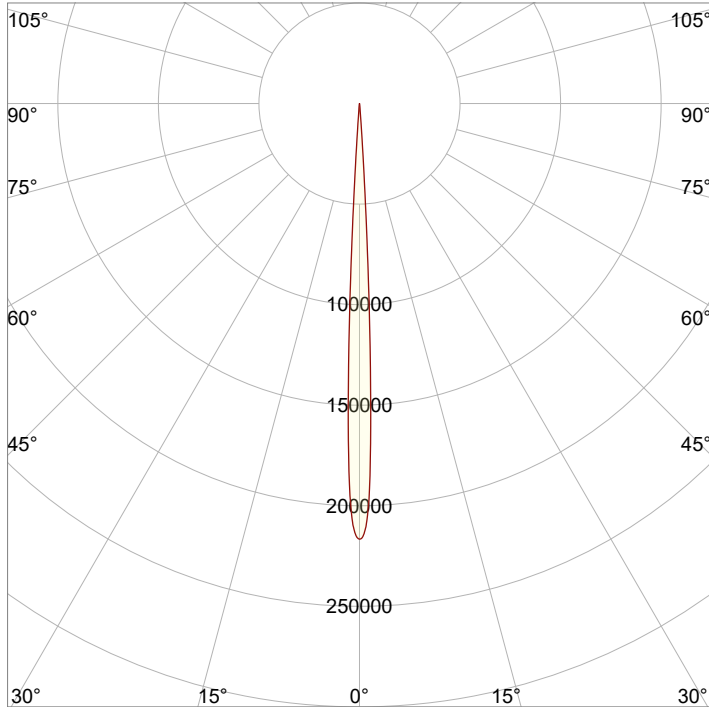

<b>Beam Angle - 50%</b>
<b>5.3°</b>
<b>Field Angle - 10%</b>
<b>7.9°</b>
<b>Cutoff Angle - 2.5%</b>
<b>9.6°</b>

### ISO Diagrams

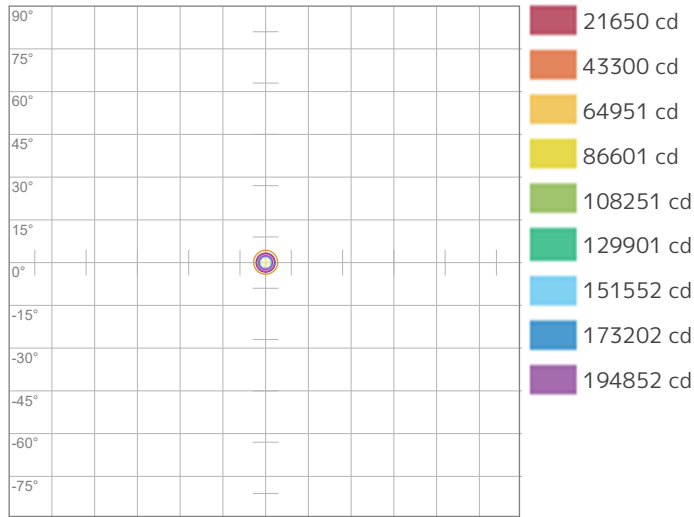

ISO Candela Diagram

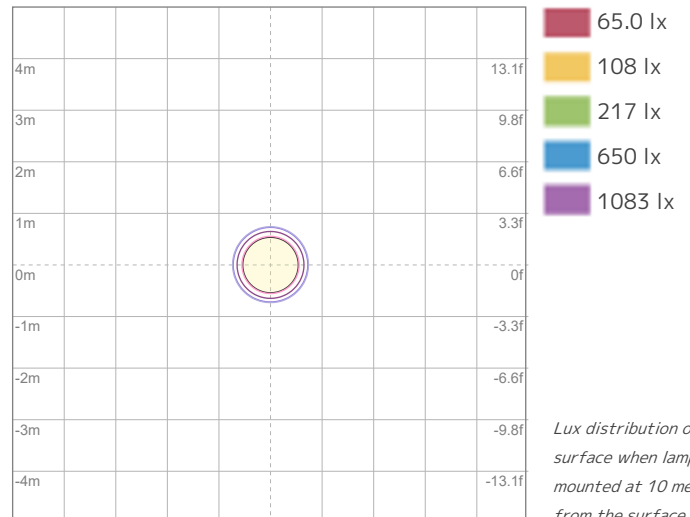

ISO LUX Diagram

*Lux distribution on a surface when lamp is mounted at 10 meters from the surface.*

Conditions:

Number of c-planes: 2

Candela at center: 216502 cd

Conditions:

Number of c-planes: 2

LUX at center: 2165 lx

### Linear Distribution

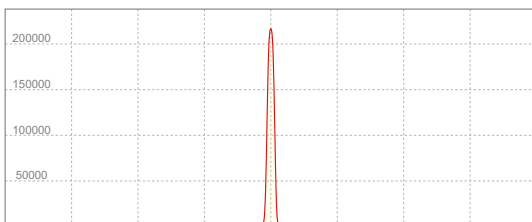

**Peak Candela**  
**216535 cd**

**Calculate Center Beam Intensities**

$$\text{lux} = 216535 / \text{distance(m)}^2$$

$$\text{fc} = 216535 / \text{distance(ft)}^2$$

### Key Measurements

#### Output

Total Lumen Output: 1892 lm  
Peak Intensity: 225770 cd

#### Beam

Beam Angle (50%): 5.3°  
Field Angle (10%): 7.9°  
Cutoff Angle (2.5%): 9.7°

#### Color

Color Temperature: 4463 K  
CRI: 73.9  
TLCI: 61  
TM30 R<sub>F</sub>: 75.7  
TM30 R<sub>g</sub>: 98.8

#### Power Details

Efficacy: 11 Lumen/Watt  
Power: 175.2 W  
Supply Voltage: 119 V  
Current: 1.49 A

### Beam Details

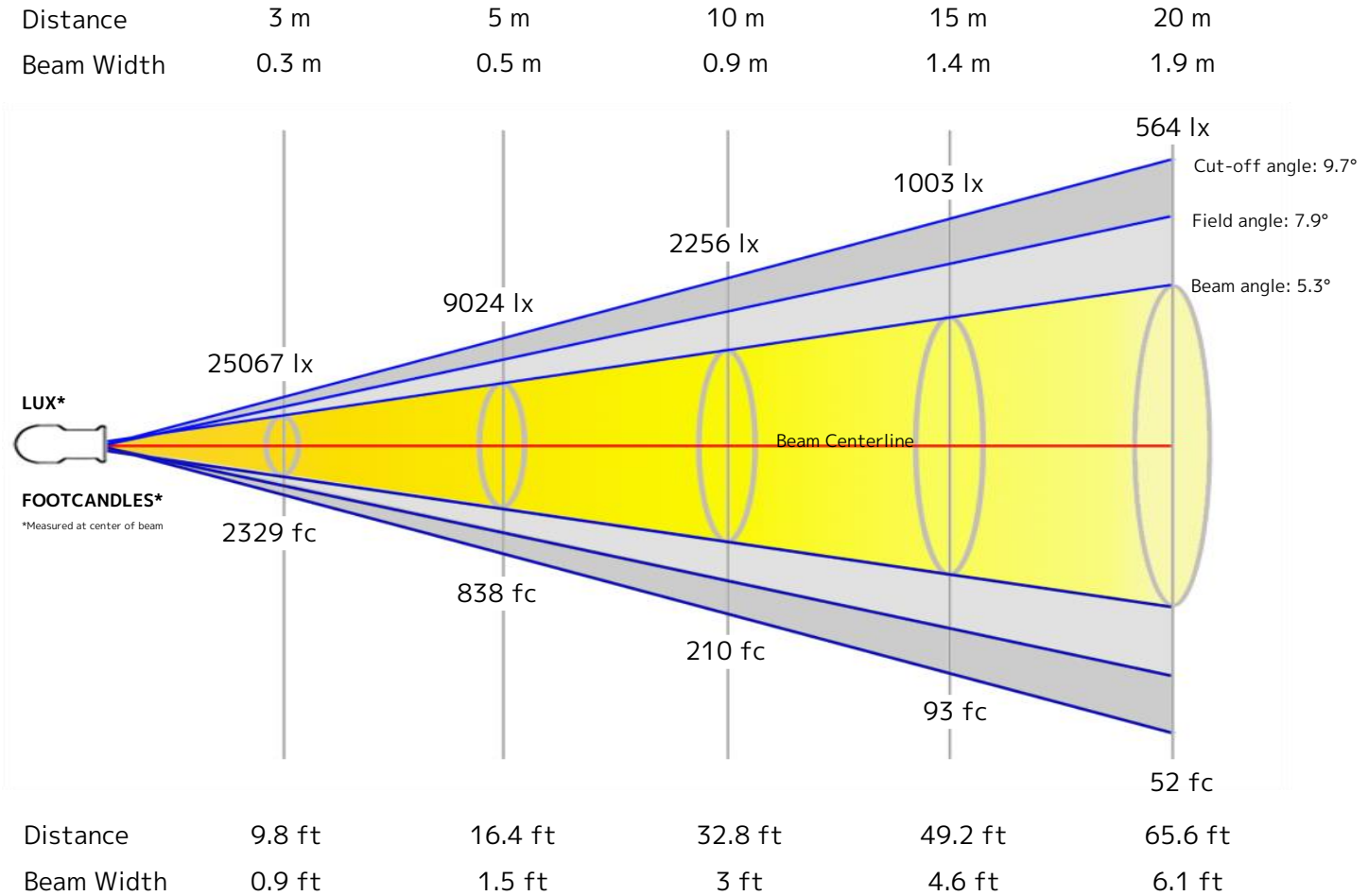

### Beam Intensities from 1-20m

M	1	2	3	4	5	6	7	8	9	10	11	12	13	14	15	16	17	18	19	20
<b>LX</b>	225607	56402	25067	14100	9024	6267	4604	3525	2785	2256	1865	1567	1335	1151	1003	881	781	696	625	564
<b>FT</b>	3.3	6.6	9.8	13.1	16.4	19.7	23	26.2	29.5	32.8	36.1	39.4	42.7	45.9	49.2	52.5	55.8	59.1	62.3	65.6
<b>FC</b>	20959.6	5239.9	2328.8	1310	838.4	582.2	427.7	327.5	258.8	209.6	173.2	145.6	124	106.9	93.2	81.9	72.5	64.7	58.1	52.4

### Angular Distribution

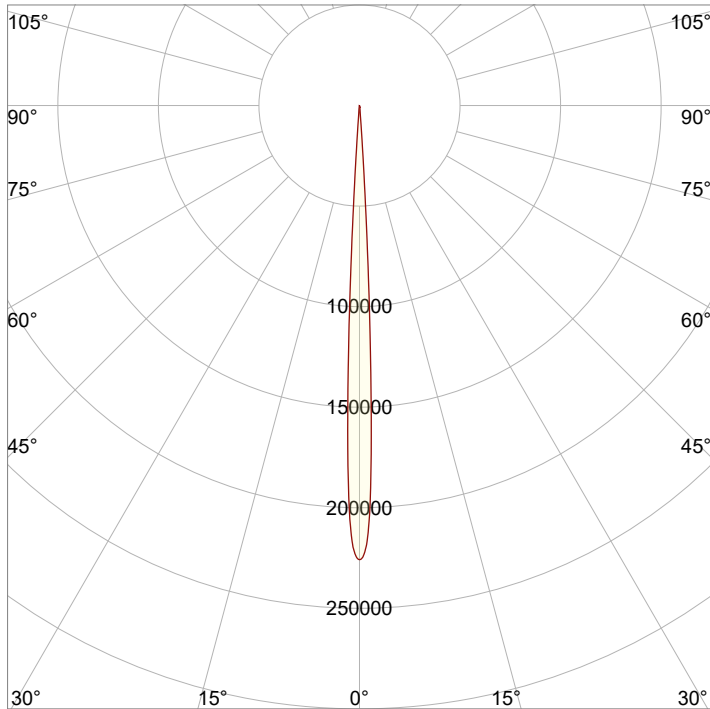

<b>Beam Angle - 50%</b>
<b>5.3°</b>
<b>Field Angle - 10%</b>
<b>7.9°</b>
<b>Cutoff Angle - 2.5%</b>
<b>9.7°</b>

### ISO Diagrams

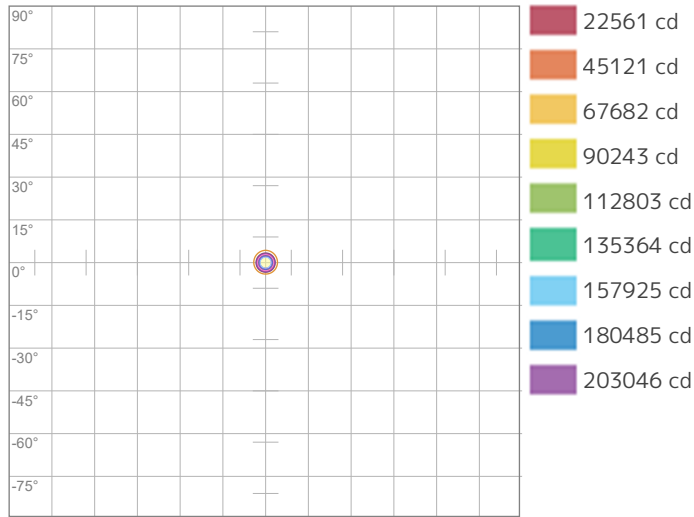

ISO Candela Diagram

Conditions:

Number of c-planes: 2

Candela at center: 225607 cd

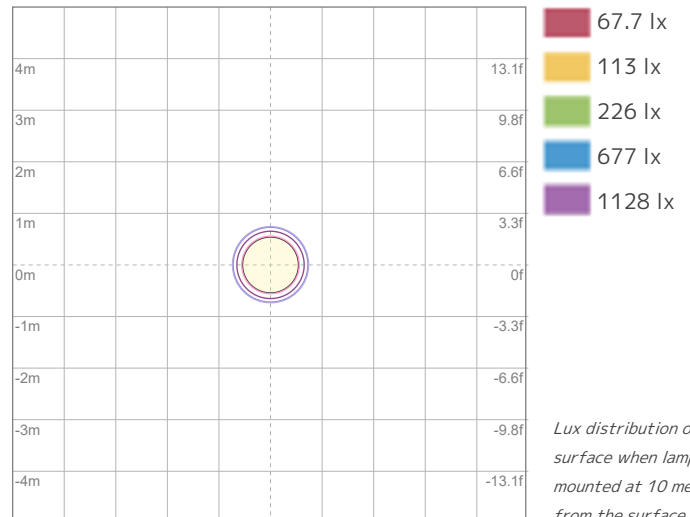

ISO LUX Diagram

Conditions:

Number of c-planes: 2

LUX at center: 2256 lx

*Lux distribution on a surface when lamp is mounted at 10 meters from the surface.*

### Linear Distribution

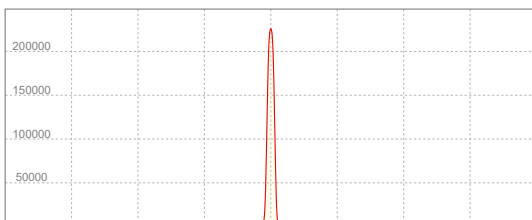

**Peak Candela**  
**225770 cd**

**Calculate Center Beam Intensities**

$$\text{lux} = 225770 / \text{distance(m)}^2$$

$$\text{fc} = 225770 / \text{distance(ft)}^2$$

### Key Measurements

#### Output

Total Lumen Output: 2051 lm  
Peak Intensity: 212638 cd

#### Beam

Beam Angle (50%): 5.4°  
Field Angle (10%): 8.2°  
Cutoff Angle (2.5%): 11.9°

#### Color

Color Temperature: 5640 K  
CRI: 75.7  
TLCI: 69  
TM30 R<sub>F</sub>: 76.7  
TM30 R<sub>g</sub>: 99.8

#### Power Details

Efficacy: 10 Lumen/Watt  
Power: 196.6 W  
Supply Voltage: 120 V  
Current: 1.66 A

### Beam Details

Distance	3 m	5 m	10 m	15 m	20 m
Beam Width	0.3 m	0.5 m	0.9 m	1.4 m	1.9 m

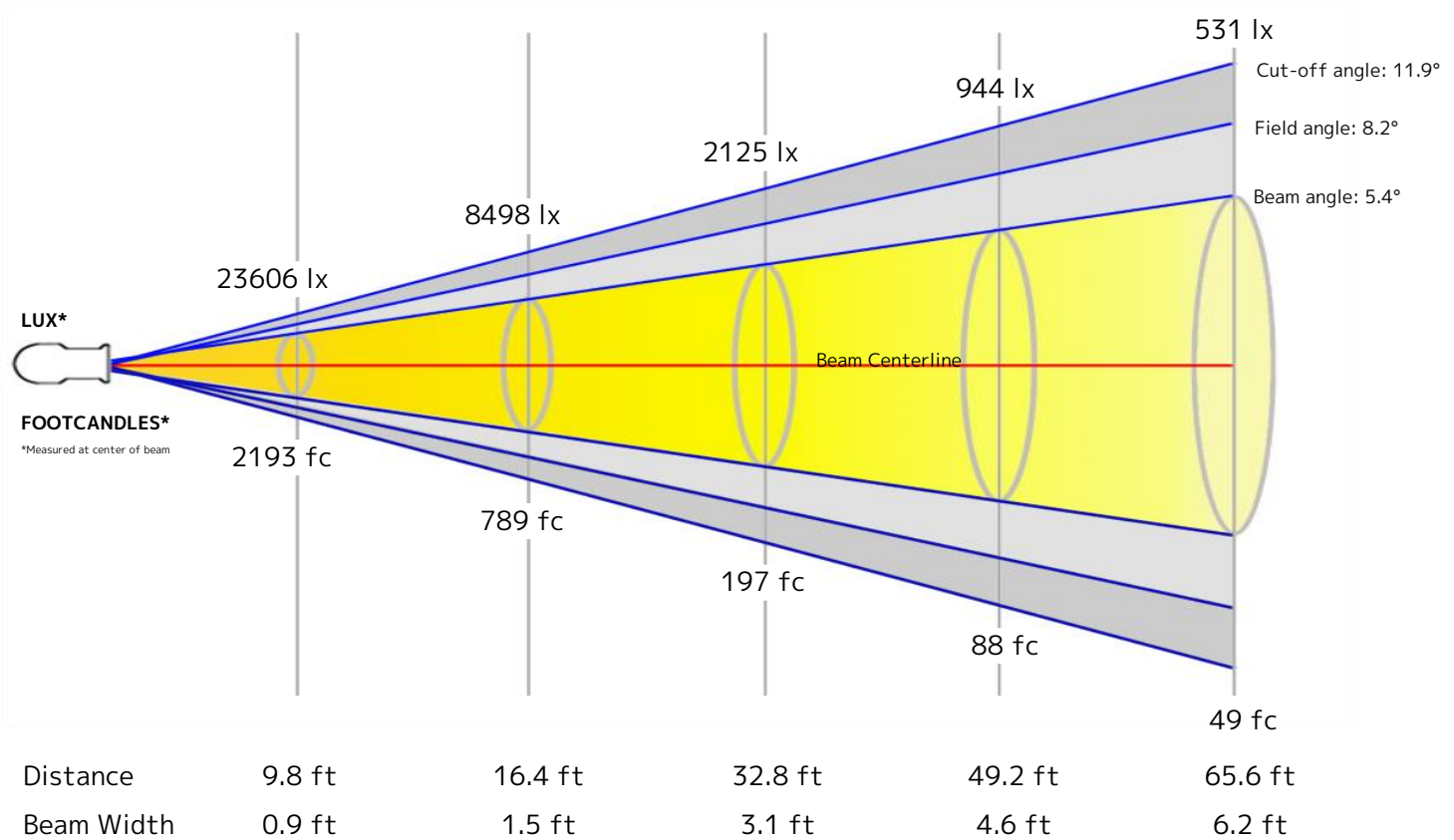

### Beam Intensities from 1-20m

M	1	2	3	4	5	6	7	8	9	10	11	12	13	14	15	16	17	18	19	20
<b>LX</b>	212451	53113	23606	13278	8498	5901	4336	3320	2623	2125	1756	1475	1257	1084	944	830	735	656	589	531
<b>FT</b>	3.3	6.6	9.8	13.1	16.4	19.7	23	26.2	29.5	32.8	36.1	39.4	42.7	45.9	49.2	52.5	55.8	59.1	62.3	65.6
<b>FC</b>	19737.4	4934.3	2193	1233.6	789.5	548.3	402.8	308.4	243.7	197.4	163.1	137.1	116.8	100.7	87.7	77.1	68.3	60.9	54.7	49.3

### Angular Distribution

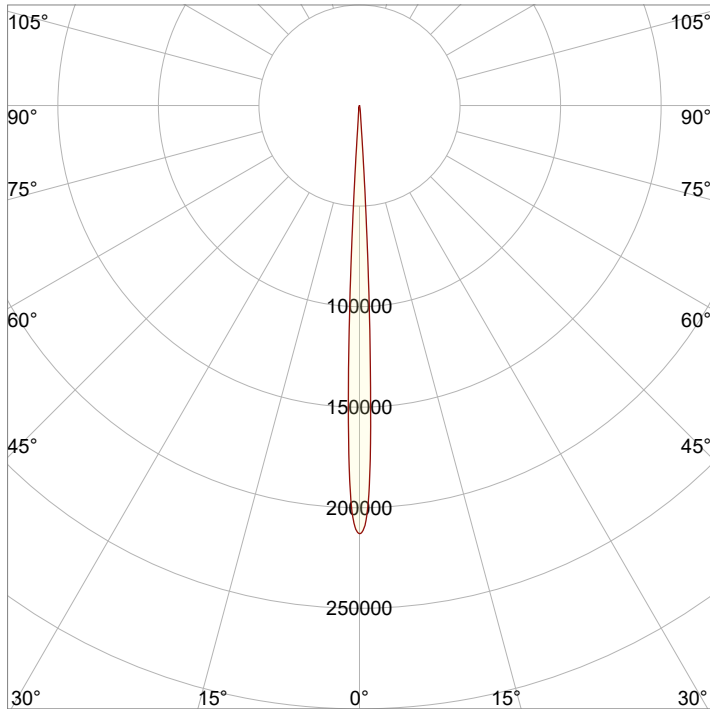

<b>Beam Angle - 50%</b>
<b>5.4°</b>
<b>Field Angle - 10%</b>
<b>8.2°</b>
<b>Cutoff Angle - 2.5%</b>
<b>11.9°</b>

### ISO Diagrams

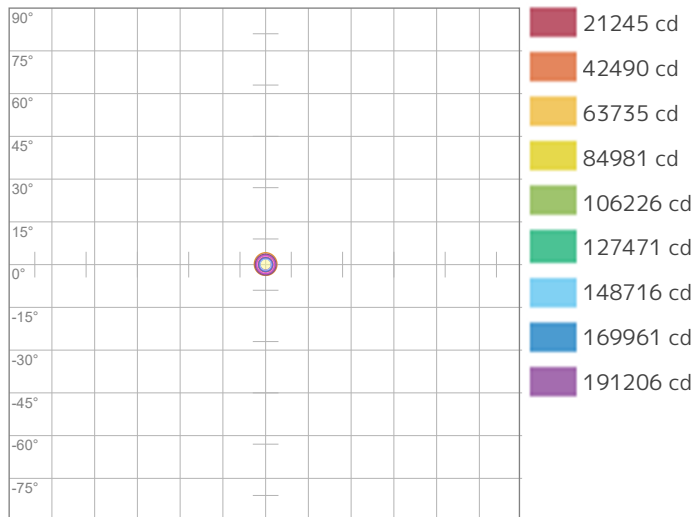

ISO Candela Diagram

Conditions:

Number of c-planes: 2

Candela at center: 212451 cd

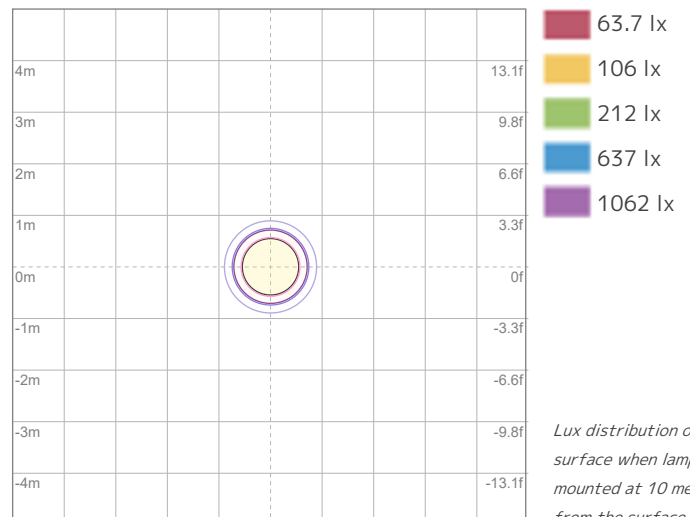

ISO LUX Diagram

Conditions:

Number of c-planes: 2

LUX at center: 2125 lx

*Lux distribution on a surface when lamp is mounted at 10 meters from the surface.*

### Linear Distribution

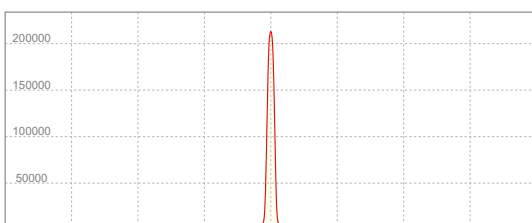

**Peak Candela**  
**212638 cd**

**Calculate Center Beam Intensities**

$$\text{lux} = 212638 / \text{distance(m)}^2$$

$$\text{fc} = 212638 / \text{distance(ft)}^2$$

## Key Measurements

### Output

Total Lumen Output: 2167 lm  
Peak Intensity: 231493 cd

### Beam

Beam Angle (50%): 5.4°  
Field Angle (10%): 8.2°  
Cutoff Angle (2.5%): 11.3°

### Color

Color Temperature: 6548 K  
CRI: 75.8  
TLCI: 70  
TM30 R<sub>F</sub>: 76.7  
TM30 R<sub>g</sub>: 98.9

### Power Details

Efficacy: 10 Lumen/Watt  
Power: 206.5 W  
Supply Voltage: 119 V  
Current: 1.75 A

## Beam Details

Distance	3 m	5 m	10 m	15 m	20 m
Beam Width	0.3 m	0.5 m	0.9 m	1.4 m	1.9 m

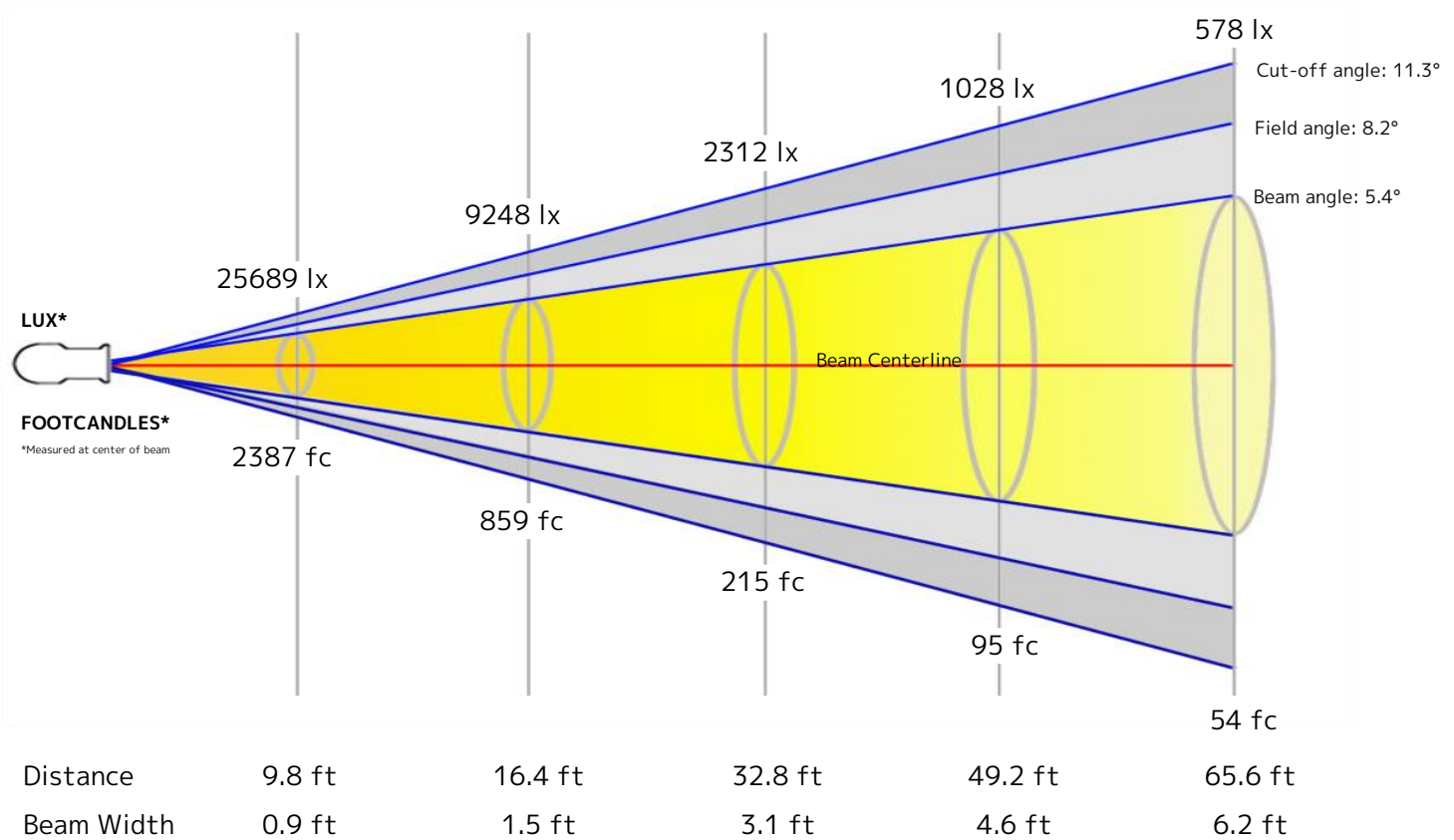

## Beam Intensities from 1-20m

M	1	2	3	4	5	6	7	8	9	10	11	12	13	14	15	16	17	18	19	20
<b>LX</b>	231200	57800	25689	14450	9248	6422	4718	3613	2854	2312	1911	1606	1368	1180	1028	903	800	714	640	578
<b>FT</b>	3.3	6.6	9.8	13.1	16.4	19.7	23	26.2	29.5	32.8	36.1	39.4	42.7	45.9	49.2	52.5	55.8	59.1	62.3	65.6
<b>FC</b>	21479.2	5369.8	2386.6	1342.5	859.2	596.6	438.4	335.6	265.2	214.8	177.5	149.2	127.1	109.6	95.5	83.9	74.3	66.3	59.5	53.7

### Angular Distribution

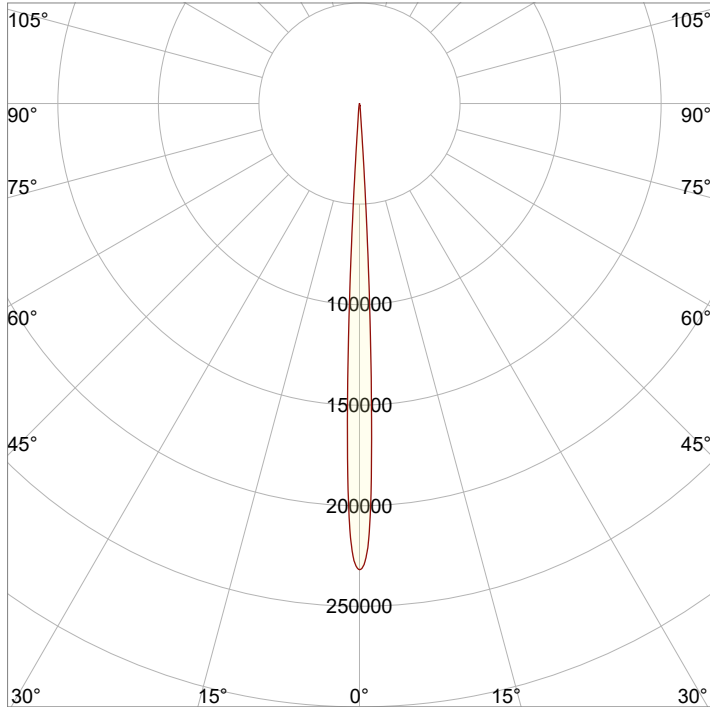

<b>Beam Angle - 50%</b>
<b>5.4°</b>
<b>Field Angle - 10%</b>
<b>8.2°</b>
<b>Cutoff Angle - 2.5%</b>
<b>11.3°</b>

### ISO Diagrams

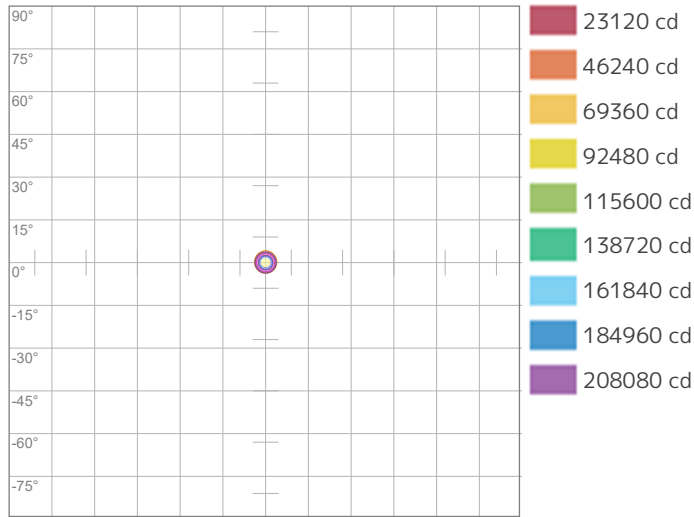

ISO Candela Diagram

Conditions:

Number of c-planes: 2

Candela at center: 231200 cd

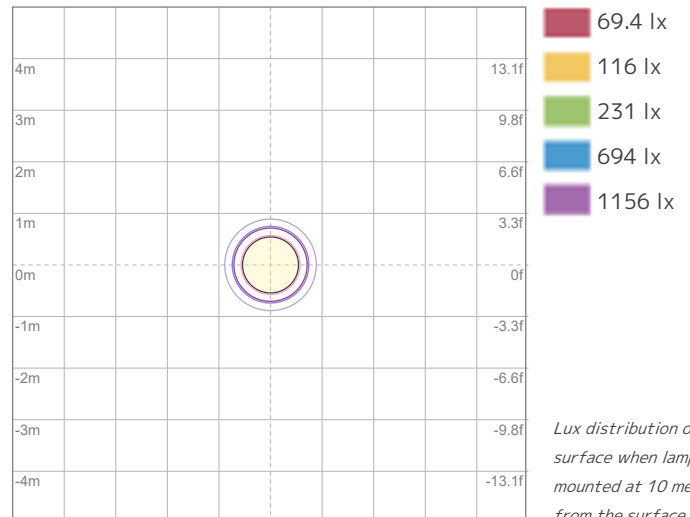

ISO LUX Diagram

Conditions:

Number of c-planes: 2

LUX at center: 2312 lx

*Lux distribution on a surface when lamp is mounted at 10 meters from the surface.*

### Linear Distribution

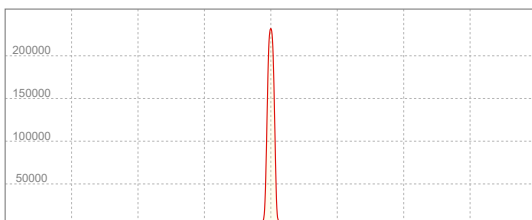

**Peak Candela**  
**231493 cd**

Calculate Center Beam Intensities

$$\text{lux} = 231493 / \text{distance(m)}^2$$

$$\text{fc} = 231493 / \text{distance(ft)}^2$$

### Key Measurements

#### Output

Total Lumen Output: 2270 lm  
Peak Intensity: 250514 cd

#### Beam

Beam Angle (50%): 5.4°  
Field Angle (10%): 8.1°  
Cutoff Angle (2.5%): 10.9°

#### Color

Color Temperature: 8419 K  
CRI: 76.1  
TLCI: 70  
TM30 R<sub>F</sub>: 76.5  
TM30 R<sub>g</sub>: 98.1

#### Power Details

Efficacy: 10 Lumen/Watt  
Power: 225.6 W  
Supply Voltage: 119 V  
Current: 1.92 A

### Beam Details

Distance	3 m	5 m	10 m	15 m	20 m
Beam Width	0.3 m	0.5 m	0.9 m	1.4 m	1.9 m

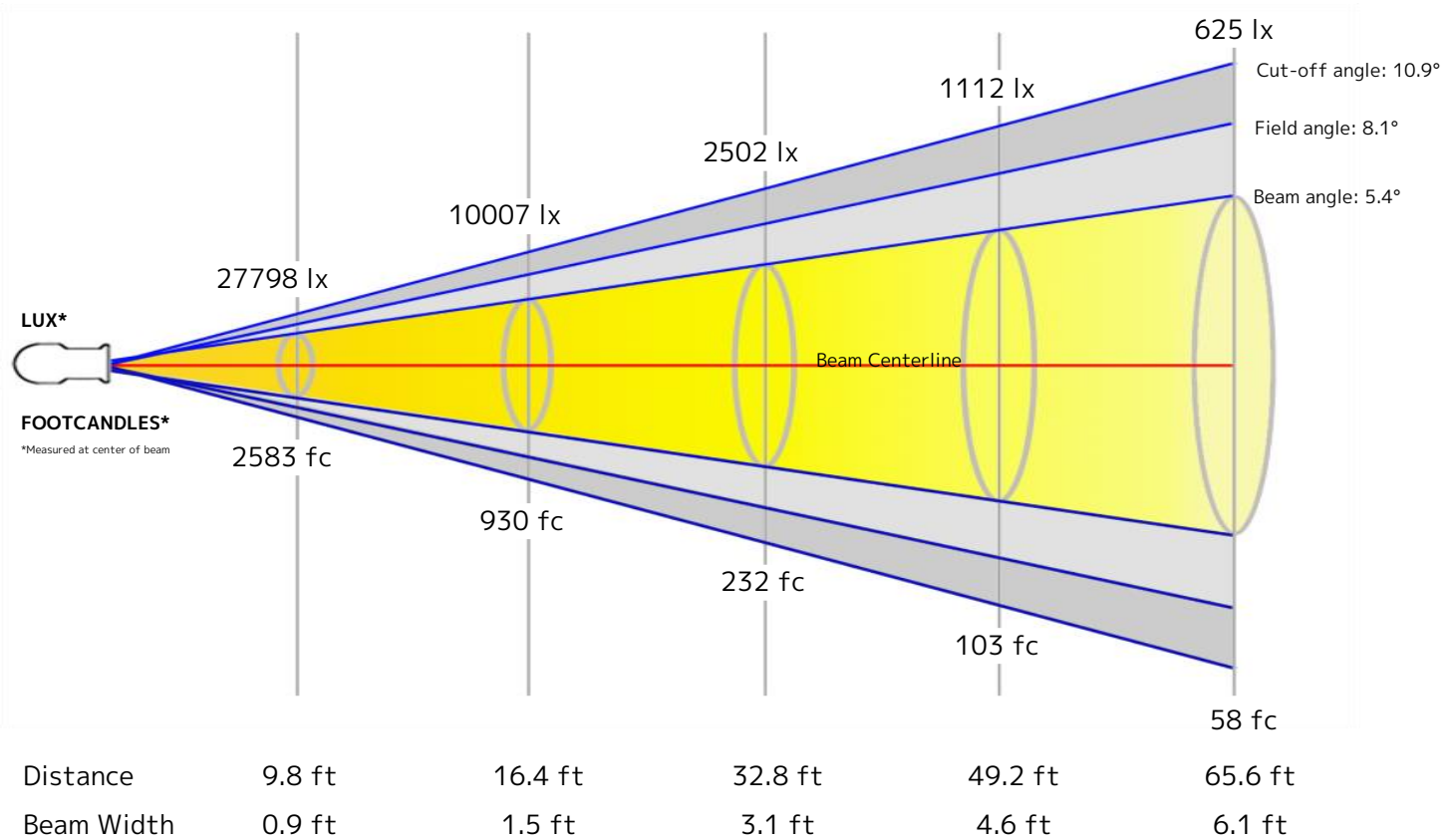

### Beam Intensities from 1-20m

M	1	2	3	4	5	6	7	8	9	10	11	12	13	14	15	16	17	18	19	20
<b>LX</b>	250182	62546	27798	15636	10007	6950	5106	3909	3089	2502	2068	1737	1480	1276	1112	977	866	772	693	625
<b>FT</b>	3.3	6.6	9.8	13.1	16.4	19.7	23	26.2	29.5	32.8	36.1	39.4	42.7	45.9	49.2	52.5	55.8	59.1	62.3	65.6
<b>FC</b>	23242.7	5810.7	2582.5	1452.7	929.7	645.6	474.3	363.2	286.9	232.4	192.1	161.4	137.5	118.6	103.3	90.8	80.4	71.7	64.4	58.1

### Angular Distribution

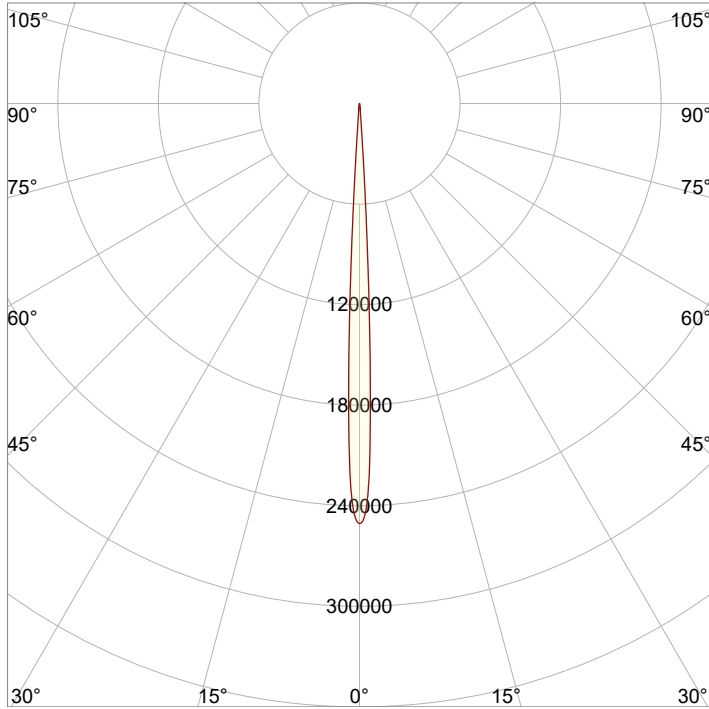

<b>Beam Angle - 50%</b>
<b>5.4°</b>
<b>Field Angle - 10%</b>
<b>8.1°</b>
<b>Cutoff Angle - 2.5%</b>
<b>10.9°</b>

### ISO Diagrams

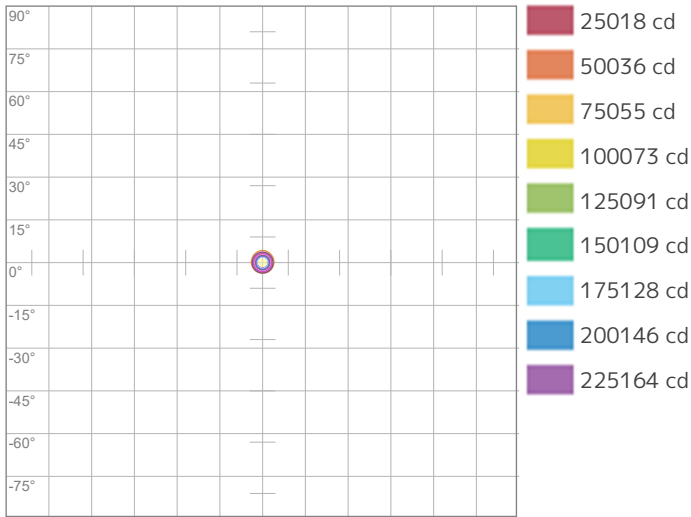

ISO Candela Diagram

Conditions:

Number of c-planes: 2

Candela at center: 250182 cd

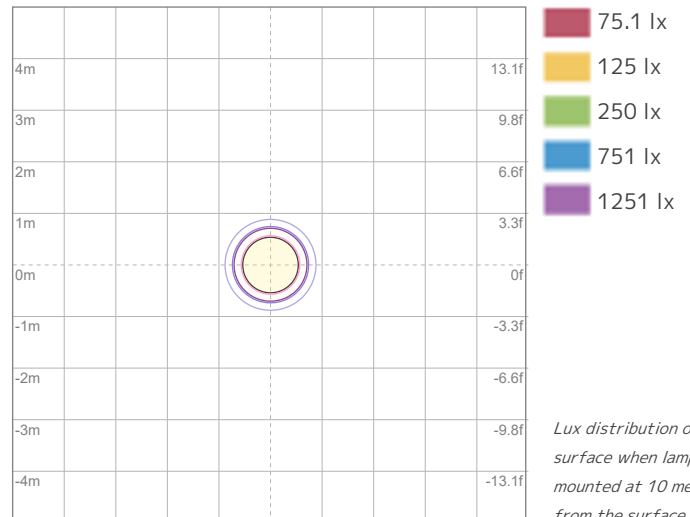

ISO LUX Diagram

Conditions:

Number of c-planes: 2

LUX at center: 2502 lx

*Lux distribution on a surface when lamp is mounted at 10 meters from the surface.*

### Linear Distribution

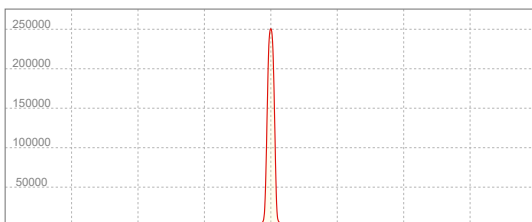

**Peak Candela**  
**250514 cd**

**Calculate Center Beam Intensities**

$$\text{lux} = 250514 / \text{distance(m)}^2$$

$$\text{fc} = 250514 / \text{distance(ft)}^2$$

## Key Measurements

### Output

Total Lumen Output: 3118 lm  
Peak Intensity: 28125 cd

### Beam

Beam Angle (50%): 21°  
Field Angle (10%): 27.7°  
Cutoff Angle (2.5%): 30.4°

### Color

Color Temperature: 0 K  
CRI: 0.0  
TLCI: n/a  
TM30 R<sub>F</sub>: 0.0  
TM30 R<sub>G</sub>: 0.0

### Power Details

Efficacy: 13 Lumen/Watt  
Power: 248.8 W  
Supply Voltage: 119 V  
Current: 2.11 A

## Beam Details

Distance	3 m	5 m	10 m	15 m	20 m
Beam Width	1.1 m	1.9 m	3.7 m	5.6 m	7.4 m

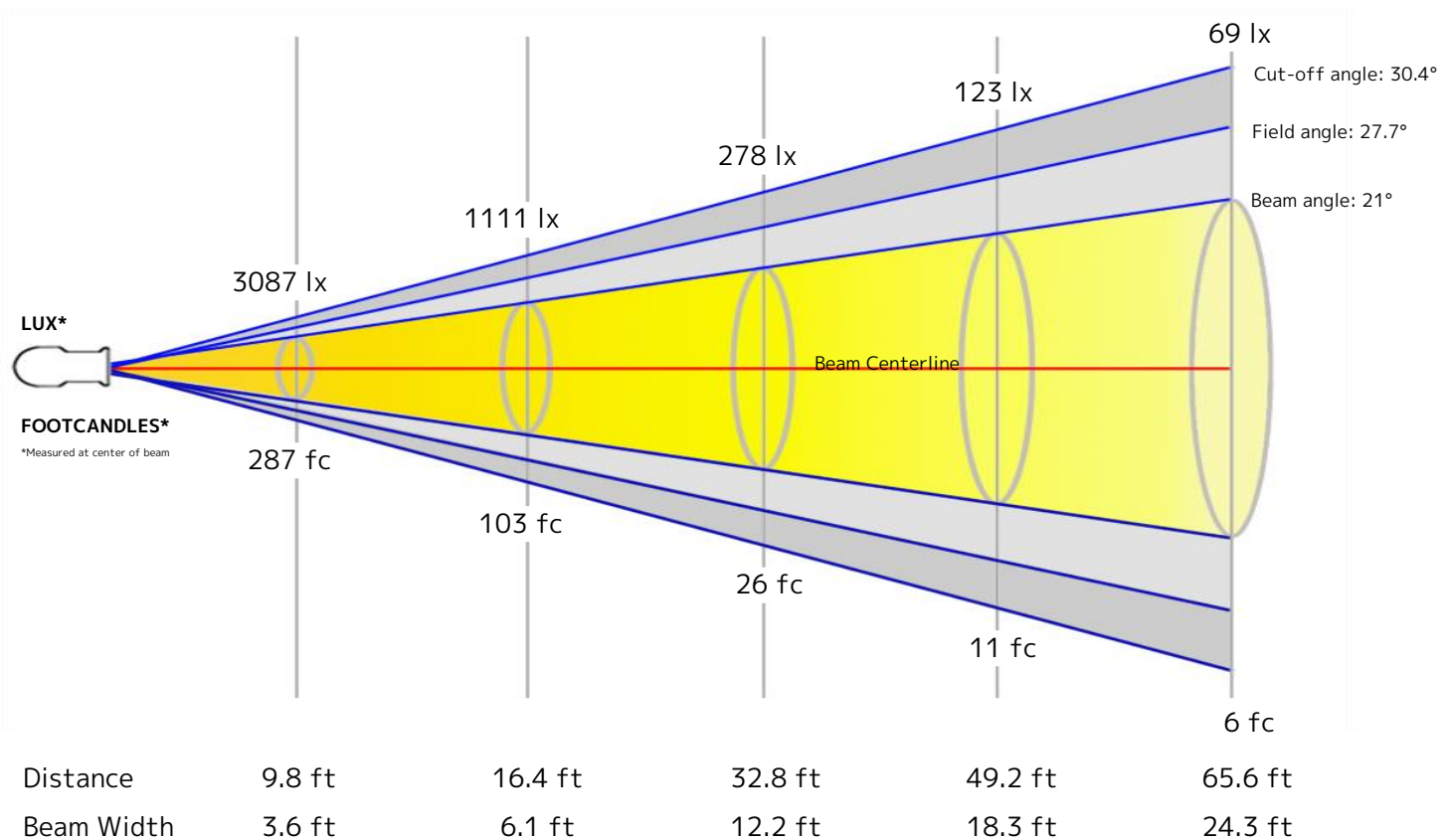

## Beam Intensities from 1-20m

M	1	2	3	4	5	6	7	8	9	10	11	12	13	14	15	16	17	18	19	20
<b>LX</b>	27782	6945	3087	1736	1111	772	567	434	343	278	230	193	164	142	123	109	96	86	77	69
<b>FT</b>	3.3	6.6	9.8	13.1	16.4	19.7	23	26.2	29.5	32.8	36.1	39.4	42.7	45.9	49.2	52.5	55.8	59.1	62.3	65.6
<b>FC</b>	2581	645.3	286.8	161.3	103.2	71.7	52.7	40.3	31.9	25.8	21.3	17.9	15.3	13.2	11.5	10.1	8.9	8	7.1	6.5

## Angular Distribution

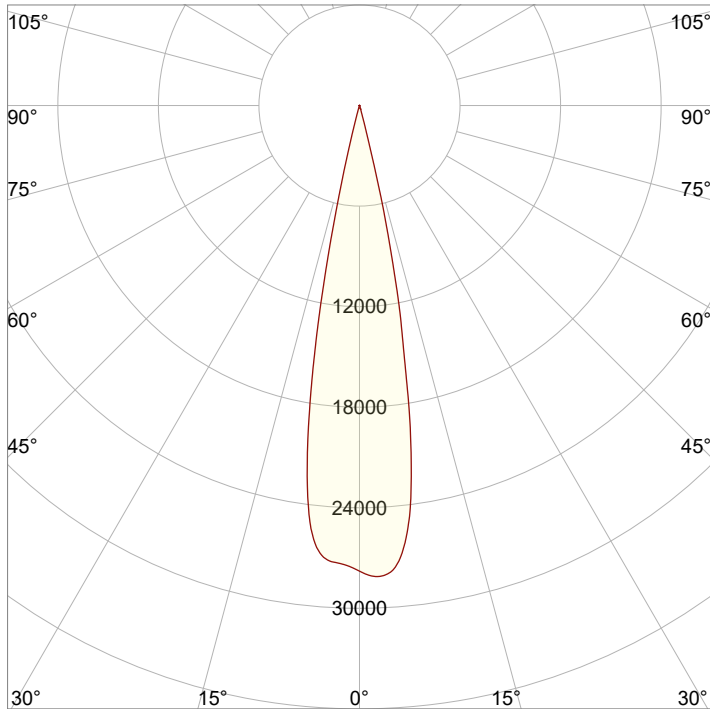

<b>Beam Angle - 50%</b>
<b>21°</b>
<b>Field Angle - 10%</b>
<b>27.7°</b>
<b>Cutoff Angle - 2.5%</b>
<b>30.4°</b>

## ISO Diagrams

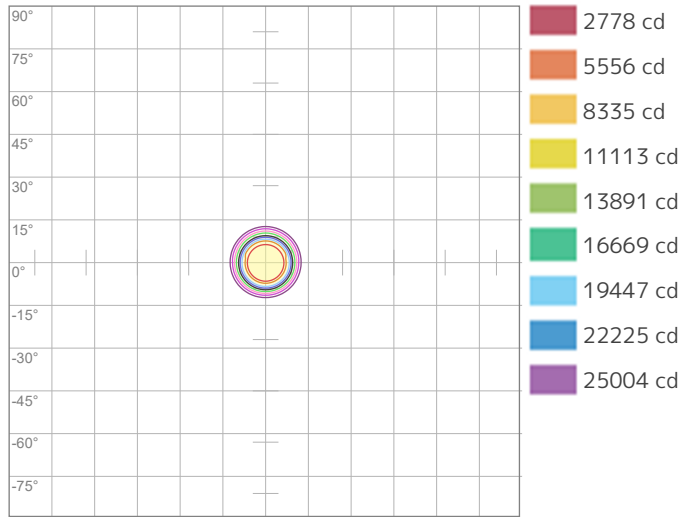

**ISO Candela Diagram**

Conditions:

Number of c-planes: 2

Candela at center: 27782 cd

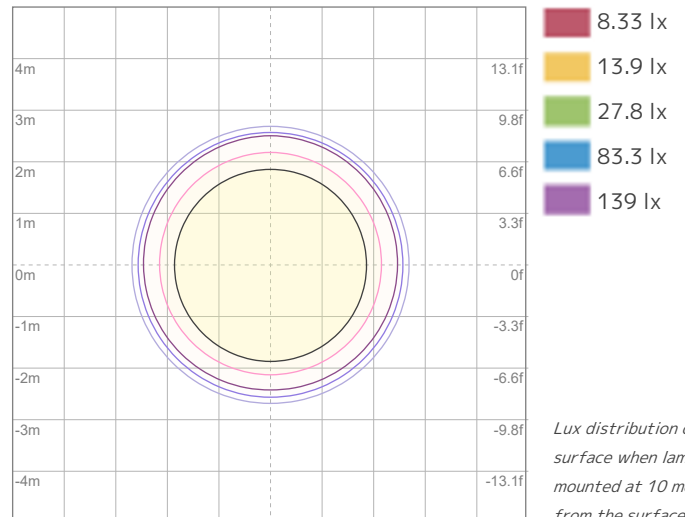

**ISO LUX Diagram**

Conditions:

Number of c-planes: 2

LUX at center: 278 lx

*Lux distribution on a surface when lamp is mounted at 10 meters from the surface.*

## Linear Distribution

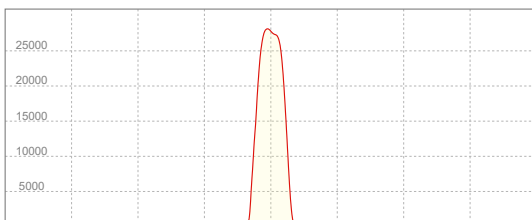

**Peak Candela**  
**28125 cd**

**Calculate Center Beam Intensities**

$$\text{lux} = 28125 / \text{distance(m)}^2$$

$$\text{fc} = 28125 / \text{distance(ft)}^2$$

### Key Measurements

#### Output

Total Lumen Output: 2879 lm  
Peak Intensity: 25175 cd

#### Beam

Beam Angle (50%): 21.5°  
Field Angle (10%): 28.6°  
Cutoff Angle (2.5%): 31.8°

#### Color

Color Temperature: 2350 K  
CRI: 78.6  
TLCI: 56  
TM30 R<sub>F</sub>: 80.5  
TM30 R<sub>g</sub>: 116.1

#### Power Details

Efficacy: 14 Lumen/Watt  
Power: 210 W  
Supply Voltage: 120 V  
Current: 1.77 A

### Beam Details

Distance	3 m	5 m	10 m	15 m	20 m
Beam Width	1.1 m	1.9 m	3.8 m	5.7 m	7.6 m

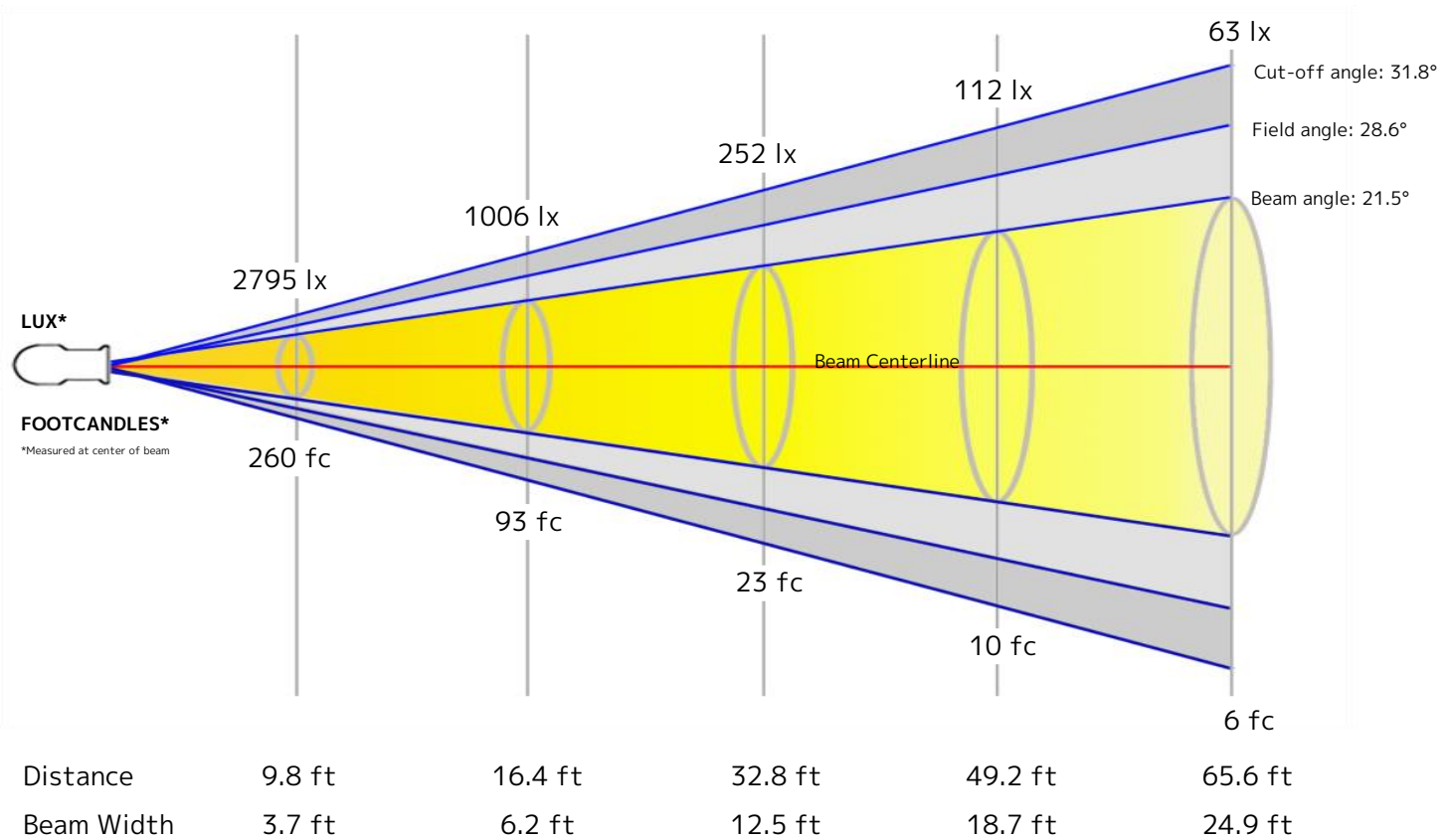

### Beam Intensities from 1-20m

M	1	2	3	4	5	6	7	8	9	10	11	12	13	14	15	16	17	18	19	20
<b>LX</b>	25157	6289	2795	1572	1006	699	513	393	311	252	208	175	149	128	112	98	87	78	70	63
<b>FT</b>	3.3	6.6	9.8	13.1	16.4	19.7	23	26.2	29.5	32.8	36.1	39.4	42.7	45.9	49.2	52.5	55.8	59.1	62.3	65.6
<b>FC</b>	2337.2	584.3	259.7	146.1	93.5	64.9	47.7	36.5	28.9	23.4	19.3	16.2	13.8	11.9	10.4	9.1	8.1	7.2	6.5	5.8

### Angular Distribution

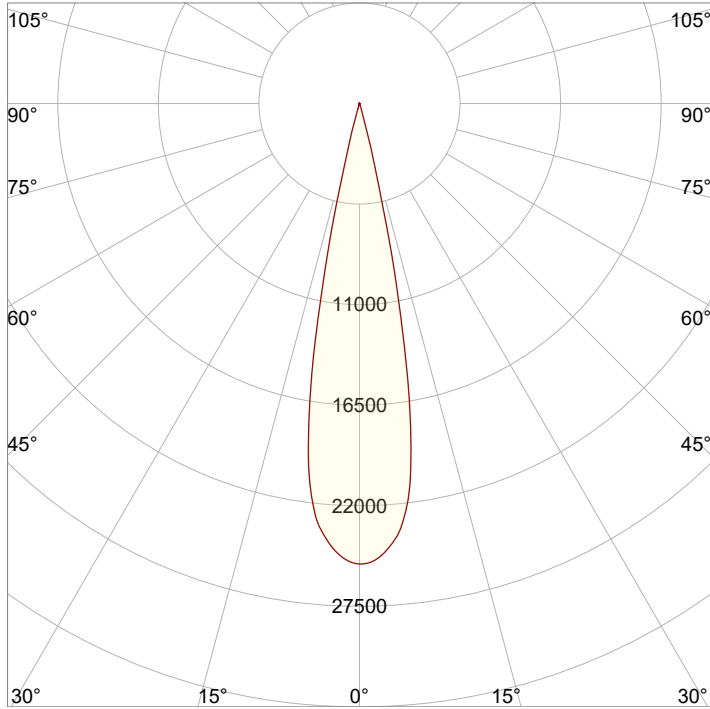

<b>Beam Angle - 50%</b>
<b>21.5°</b>
<b>Field Angle - 10%</b>
<b>28.6°</b>
<b>Cutoff Angle - 2.5%</b>
<b>31.8°</b>

### ISO Diagrams

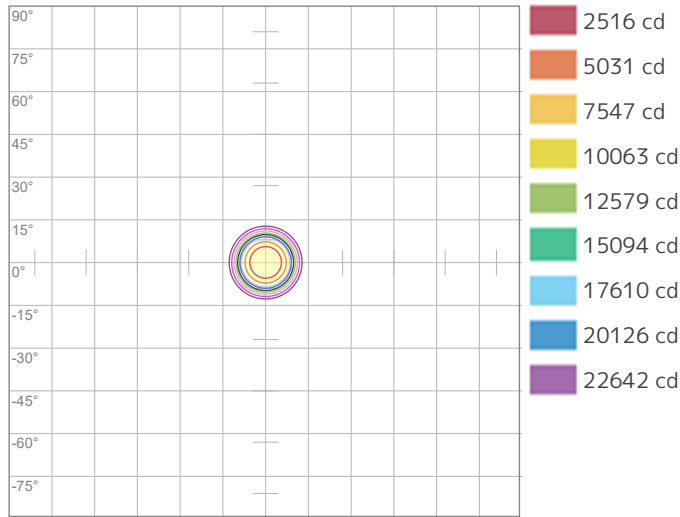

ISO Candela Diagram

Conditions:

Number of c-planes: 2

Candela at center: 25157 cd

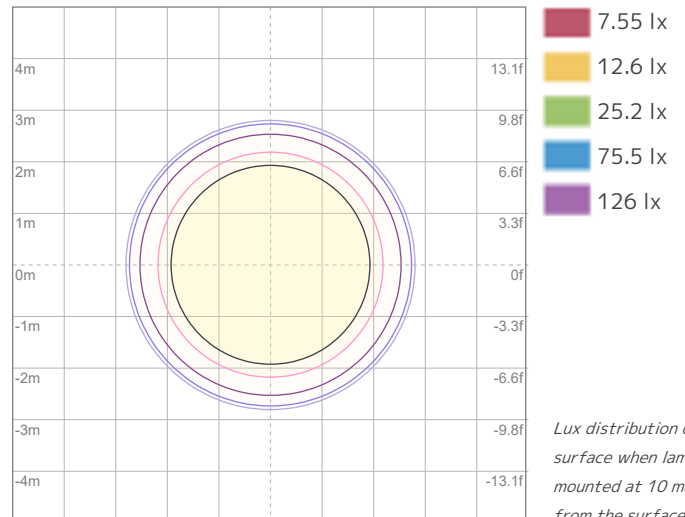

ISO LUX Diagram

Conditions:

Number of c-planes: 2

LUX at center: 252 lx

*Lux distribution on a surface when lamp is mounted at 10 meters from the surface.*

### Linear Distribution

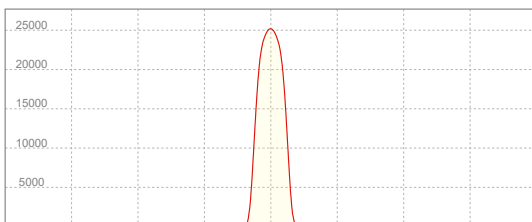

**Peak Candela**  
**25175 cd**

**Calculate Center Beam Intensities**

$$\text{lux} = 25175 / \text{distance(m)}^2$$

$$\text{fc} = 25175 / \text{distance(ft)}^2$$

### Key Measurements

#### Output

Total Lumen Output: 3098 lm  
Peak Intensity: 29341 cd

#### Beam

Beam Angle (50%): 20.6°  
Field Angle (10%): 27.8°  
Cutoff Angle (2.5%): 30.8°

#### Color

Color Temperature: 3176 K  
CRI: 82.8  
TLCI: 74  
TM30 R<sub>F</sub>: 84.6  
TM30 R<sub>G</sub>: 103.1

#### Power Details

Efficacy: 18 Lumen/Watt  
Power: 171.4 W  
Supply Voltage: 120 V  
Current: 1.46 A

### Beam Details

Distance	3 m	5 m	10 m	15 m	20 m
Beam Width	1.1 m	1.8 m	3.6 m	5.5 m	7.3 m

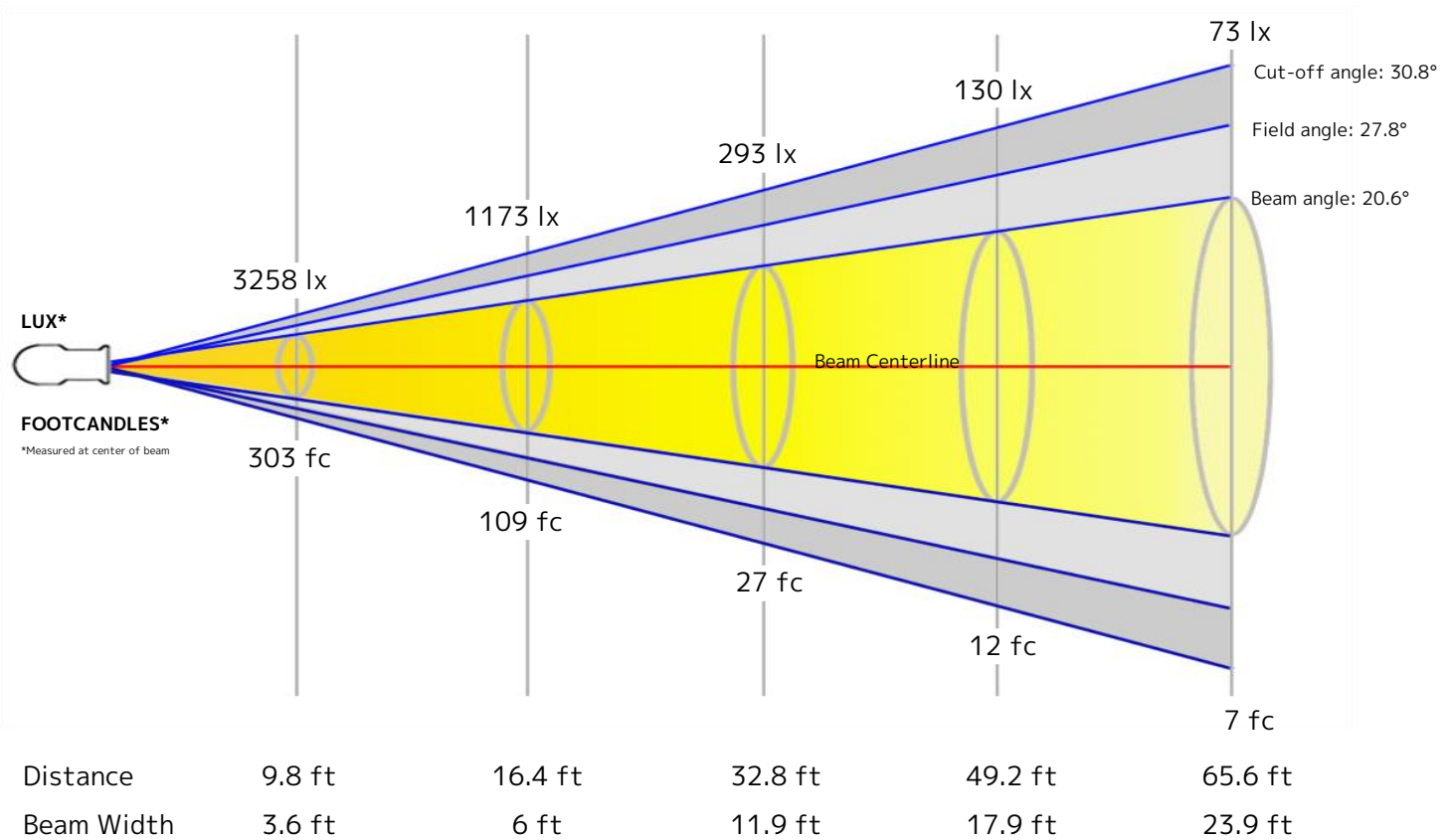

### Beam Intensities from 1-20m

M	1	2	3	4	5	6	7	8	9	10	11	12	13	14	15	16	17	18	19	20
<b>LX</b>	29321	7330	3258	1833	1173	814	598	458	362	293	242	204	173	150	130	115	101	90	81	73
<b>FT</b>	3.3	6.6	9.8	13.1	16.4	19.7	23	26.2	29.5	32.8	36.1	39.4	42.7	45.9	49.2	52.5	55.8	59.1	62.3	65.6
<b>FC</b>	2724	681	302.7	170.2	109	75.7	55.6	42.6	33.6	27.2	22.5	18.9	16.1	13.9	12.1	10.6	9.4	8.4	7.5	6.8

### Angular Distribution

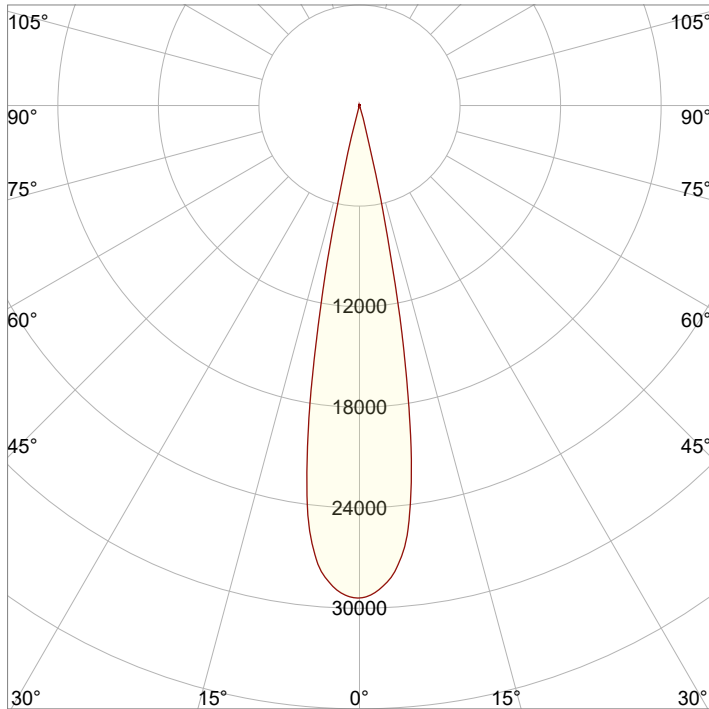

<b>Beam Angle - 50%</b>
<b>20.6°</b>
<b>Field Angle - 10%</b>
<b>27.8°</b>
<b>Cutoff Angle - 2.5%</b>
<b>30.8°</b>

### ISO Diagrams

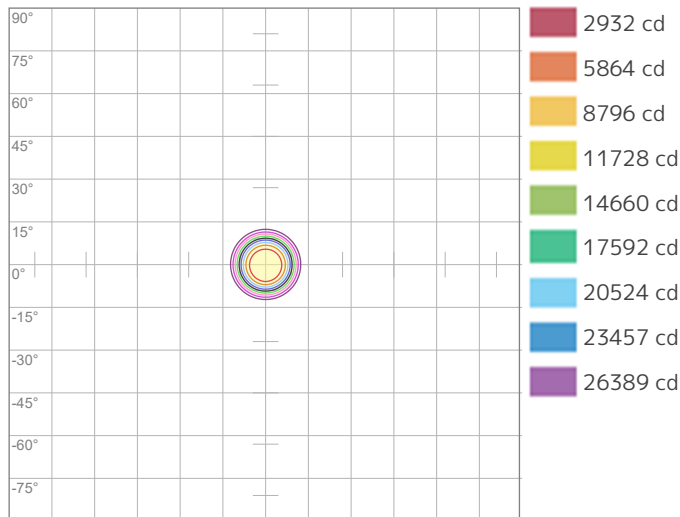

ISO Candela Diagram

Conditions:

Number of c-planes: 2

Candela at center: 29321 cd

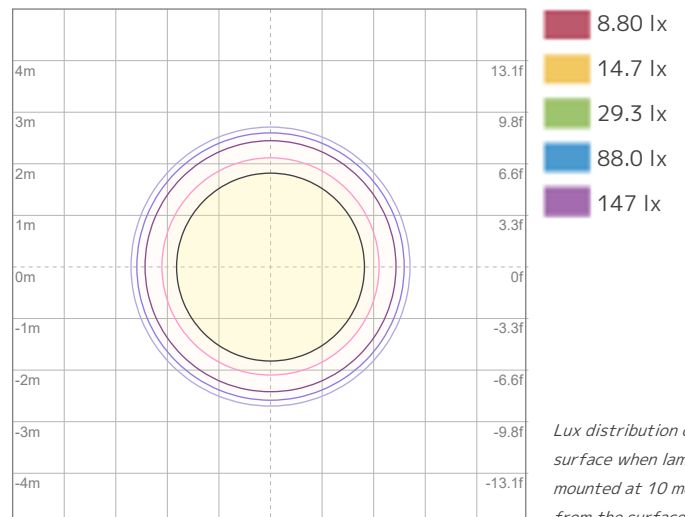

ISO LUX Diagram

Conditions:

Number of c-planes: 2

LUX at center: 293 lx

*Lux distribution on a surface when lamp is mounted at 10 meters from the surface.*

### Linear Distribution

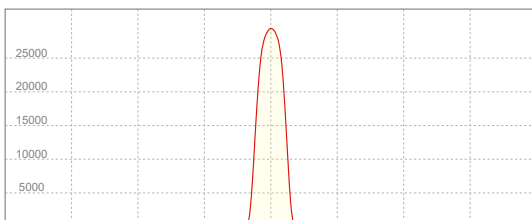

**Peak Candela**  
**29341 cd**

**Calculate Center Beam Intensities**

$$\text{lux} = 29341 / \text{distance(m)}^2$$

$$\text{fc} = 29341 / \text{distance(ft)}^2$$

### Key Measurements

#### Output

Total Lumen Output: 3260 lm  
Peak Intensity: 31610 cd

#### Beam

Beam Angle (50%): 20.6°  
Field Angle (10%): 26.7°  
Cutoff Angle (2.5%): 28.8°

#### Color

Color Temperature: 4519 K  
CRI: 73.9  
TLCI: 61  
TM30 R<sub>F</sub>: 75.6  
TM30 R<sub>g</sub>: 98.9

#### Power Details

Efficacy: 19 Lumen/Watt  
Power: 175.3 W  
Supply Voltage: 120 V  
Current: 1.49 A

### Beam Details

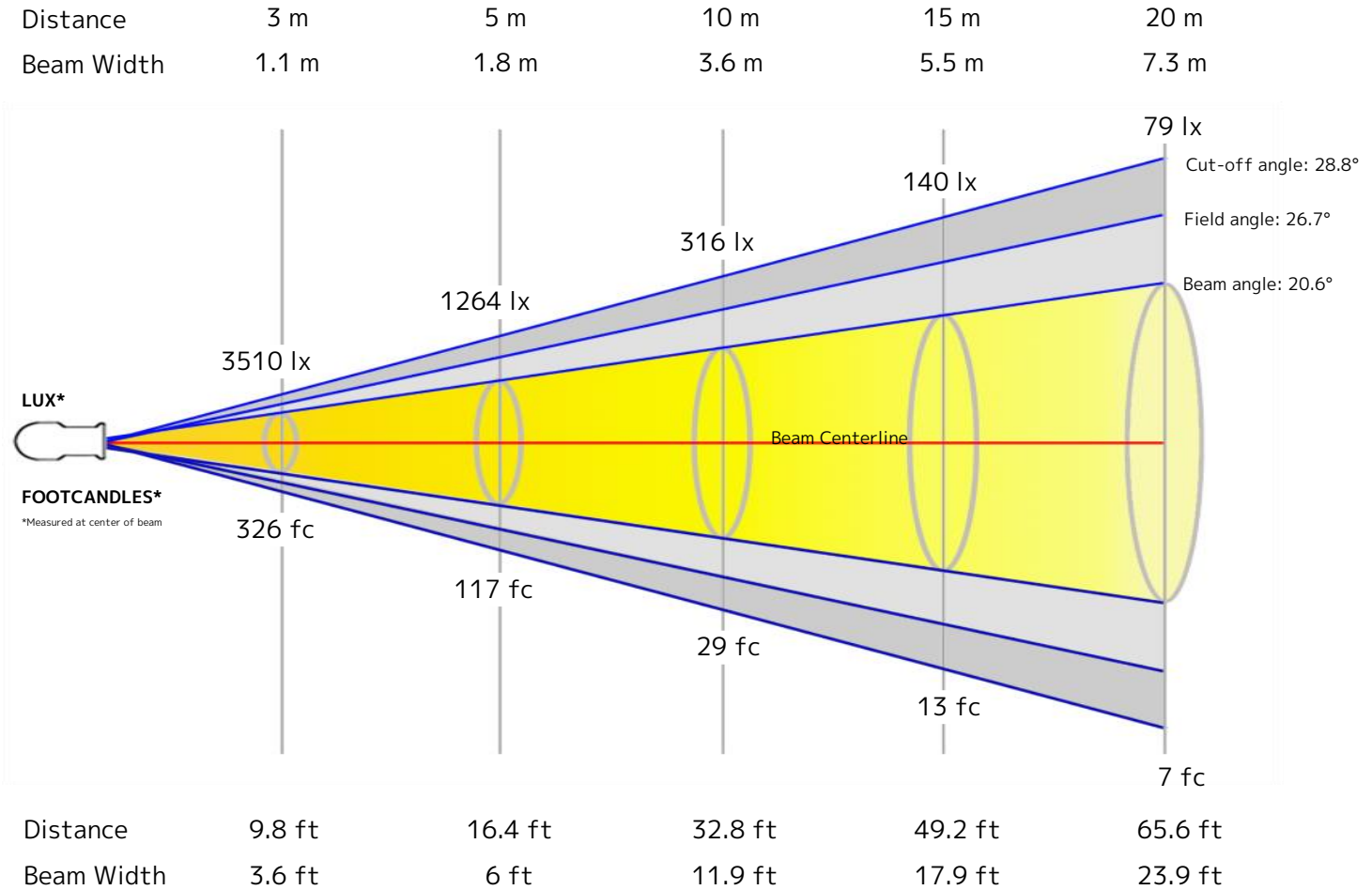

### Beam Intensities from 1-20m

M	1	2	3	4	5	6	7	8	9	10	11	12	13	14	15	16	17	18	19	20
<b>LX</b>	31589	7897	3510	1974	1264	877	645	494	390	316	261	219	187	161	140	123	109	97	88	79
<b>FT</b>	3.3	6.6	9.8	13.1	16.4	19.7	23	26.2	29.5	32.8	36.1	39.4	42.7	45.9	49.2	52.5	55.8	59.1	62.3	65.6
<b>FC</b>	2934.7	733.7	326.1	183.4	117.4	81.5	59.9	45.9	36.2	29.3	24.3	20.4	17.4	15	13	11.5	10.2	9.1	8.1	7.3

### Angular Distribution

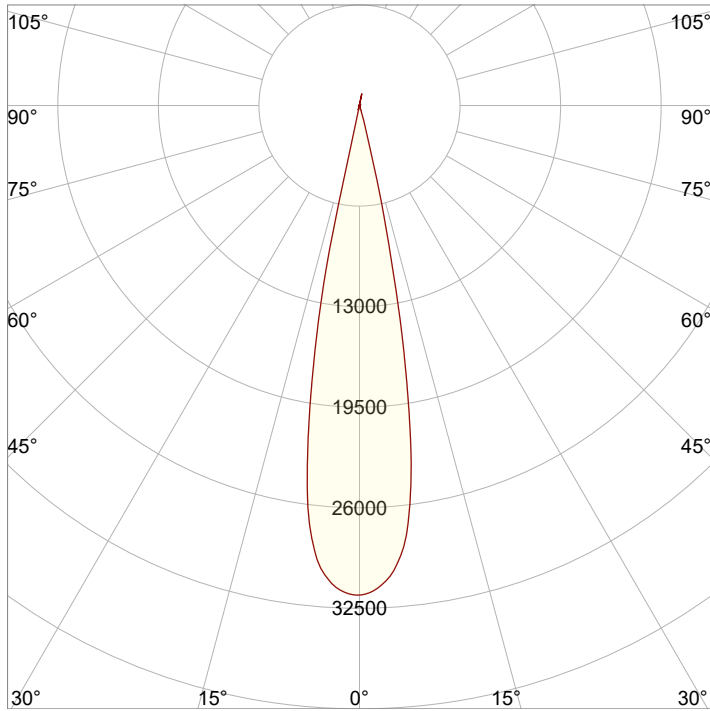

<b>Beam Angle - 50%</b>
<b>20.6°</b>
<b>Field Angle - 10%</b>
<b>26.7°</b>
<b>Cutoff Angle - 2.5%</b>
<b>28.8°</b>

### ISO Diagrams

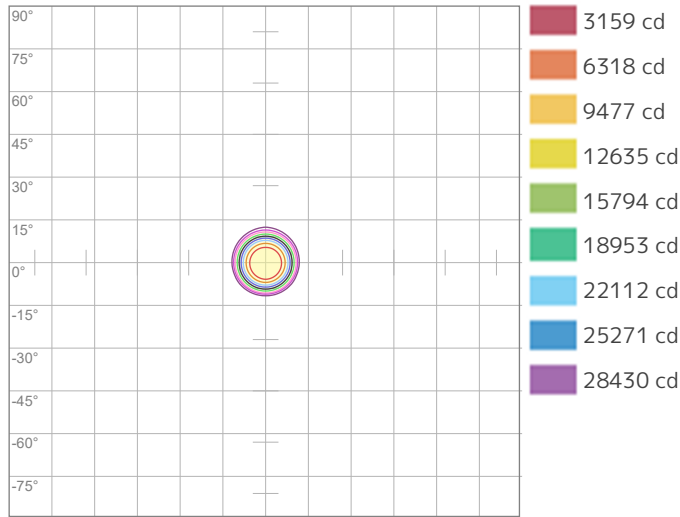

ISO Candela Diagram

Conditions:

Number of c-planes: 2

Candela at center: 31589 cd

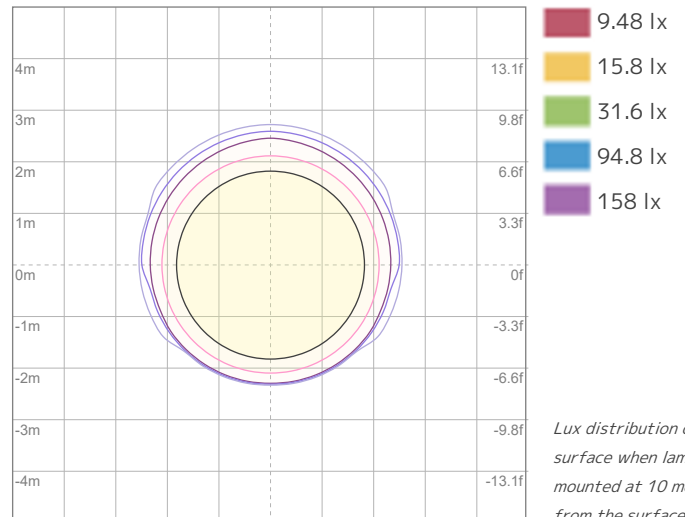

ISO LUX Diagram

Conditions:

Number of c-planes: 2

LUX at center: 316 lx

*Lux distribution on a surface when lamp is mounted at 10 meters from the surface.*

### Linear Distribution

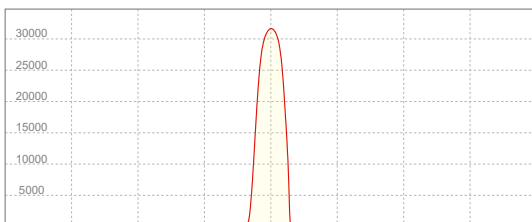

**Peak Candela**  
**31610 cd**

**Calculate Center Beam Intensities**

$$\text{lux} = 31610 / \text{distance(m)}^2$$

$$\text{fc} = 31610 / \text{distance(ft)}^2$$

### Key Measurements

#### Output

Total Lumen Output: 3667 lm  
Peak Intensity: 34643 cd

#### Beam

Beam Angle (50%): 20.6°  
Field Angle (10%): 27.9°  
Cutoff Angle (2.5%): 30.2°

#### Color

Color Temperature: 5682 K  
CRI: 74.4  
TLCI: 66  
TM30 R<sub>F</sub>: 75.8  
TM30 R<sub>g</sub>: 99.2

#### Power Details

Efficacy: 19 Lumen/Watt  
Power: 194.1 W  
Supply Voltage: 119 V  
Current: 1.64 A

### Beam Details

Distance	3 m	5 m	10 m	15 m	20 m
Beam Width	1.1 m	1.8 m	3.6 m	5.4 m	7.3 m

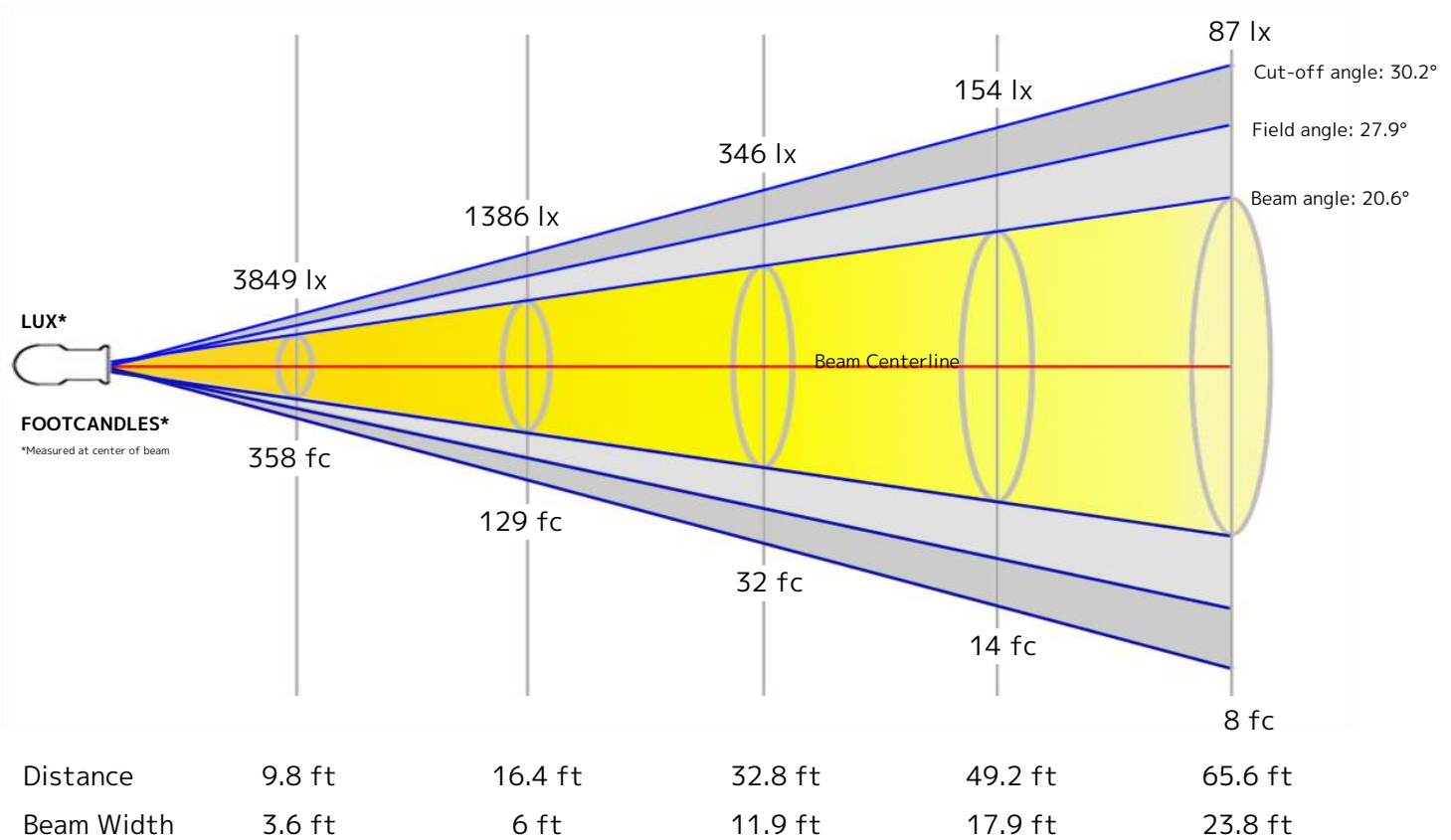

### Beam Intensities from 1-20m

M	1	2	3	4	5	6	7	8	9	10	11	12	13	14	15	16	17	18	19	20
<b>LX</b>	34642	8661	3849	2165	1386	962	707	541	428	346	286	241	205	177	154	135	120	107	96	87
<b>FT</b>	3.3	6.6	9.8	13.1	16.4	19.7	23	26.2	29.5	32.8	36.1	39.4	42.7	45.9	49.2	52.5	55.8	59.1	62.3	65.6
<b>FC</b>	3218.4	804.6	357.6	201.1	128.7	89.4	65.7	50.3	39.7	32.2	26.6	22.3	19	16.4	14.3	12.6	11.1	9.9	8.9	8

### Angular Distribution

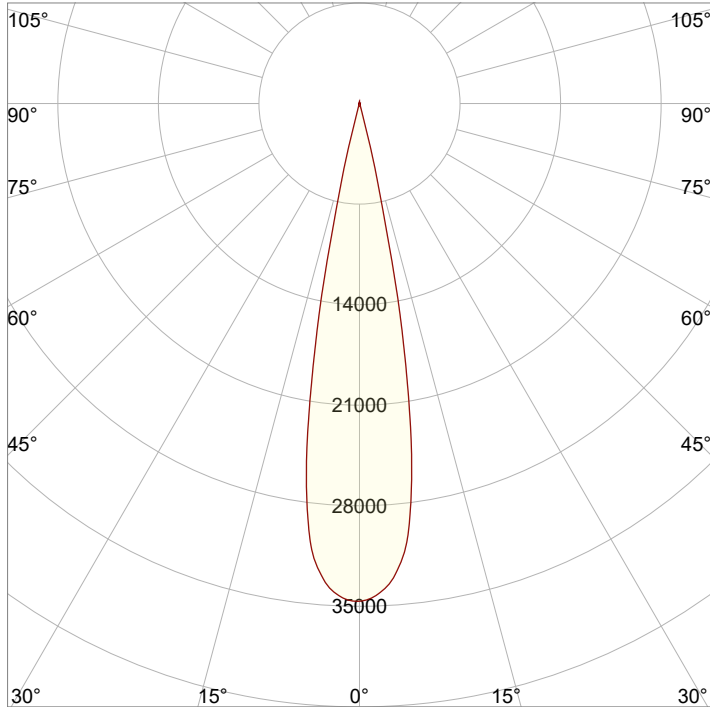

<b>Beam Angle - 50%</b>
<b>20.6°</b>
<b>Field Angle - 10%</b>
<b>27.9°</b>
<b>Cutoff Angle - 2.5%</b>
<b>30.2°</b>

### ISO Diagrams

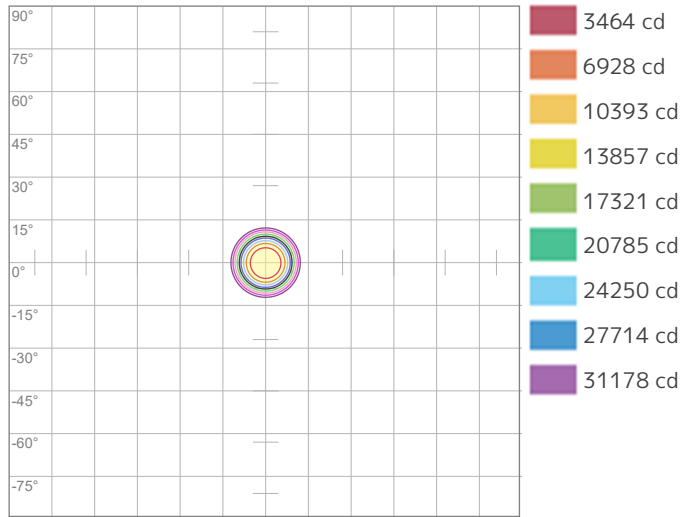

ISO Candela Diagram

Conditions:

Number of c-planes: 2

Candela at center: 34642 cd

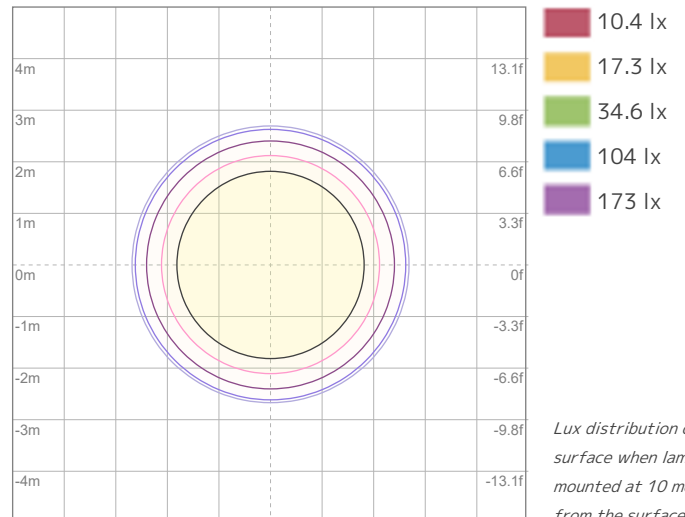

ISO LUX Diagram

Conditions:

Number of c-planes: 2

LUX at center: 346 lx

*Lux distribution on a surface when lamp is mounted at 10 meters from the surface.*

### Linear Distribution

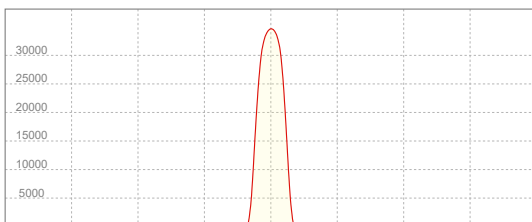

**Peak Candela**  
**34643 cd**

**Calculate Center Beam Intensities**

$$\text{lux} = 34643 / \text{distance(m)}^2$$

$$\text{fc} = 34643 / \text{distance(ft)}^2$$

### Key Measurements

#### Output

Total Lumen Output: 3767 lm  
Peak Intensity: 33422 cd

#### Beam

Beam Angle (50%): 21°  
Field Angle (10%): 28.3°  
Cutoff Angle (2.5%): 32.2°

#### Color

Color Temperature: 6510 K  
CRI: 75.3  
TLCI: 69  
TM30 R<sub>F</sub>: 76.4  
TM30 R<sub>g</sub>: 98.9

#### Power Details

Efficacy: 18 Lumen/Watt  
Power: 206.5 W  
Supply Voltage: 119 V  
Current: 1.75 A

### Beam Details

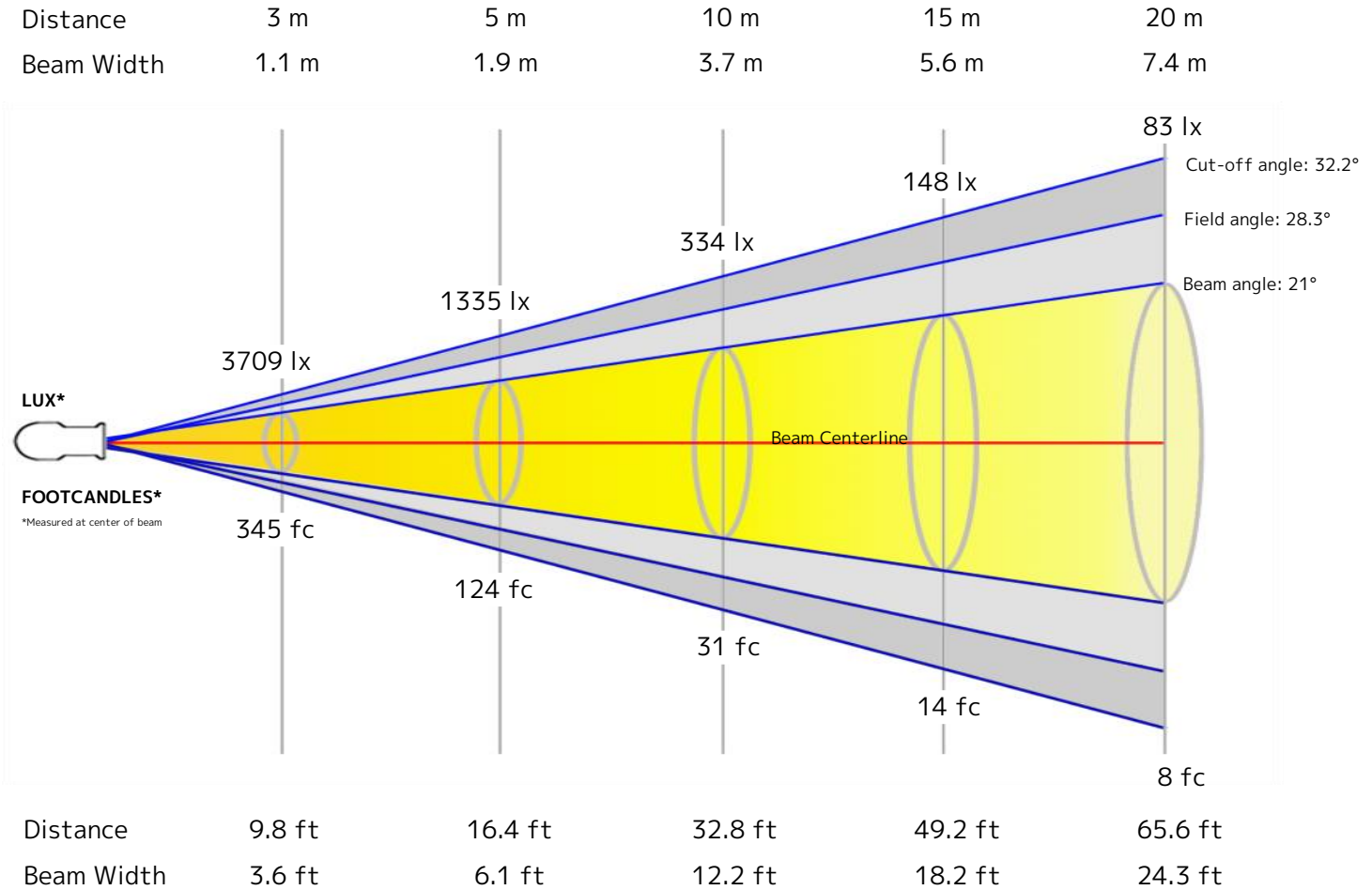

### Beam Intensities from 1-20m

M	1	2	3	4	5	6	7	8	9	10	11	12	13	14	15	16	17	18	19	20
<b>LX</b>	33378	8344	3709	2086	1335	927	681	522	412	334	276	232	198	170	148	130	115	103	92	83
<b>FT</b>	3.3	6.6	9.8	13.1	16.4	19.7	23	26.2	29.5	32.8	36.1	39.4	42.7	45.9	49.2	52.5	55.8	59.1	62.3	65.6
<b>FC</b>	3100.9	775.2	344.5	193.8	124	86.1	63.3	48.5	38.3	31	25.6	21.5	18.3	15.8	13.8	12.1	10.7	9.6	8.6	7.8

### Angular Distribution

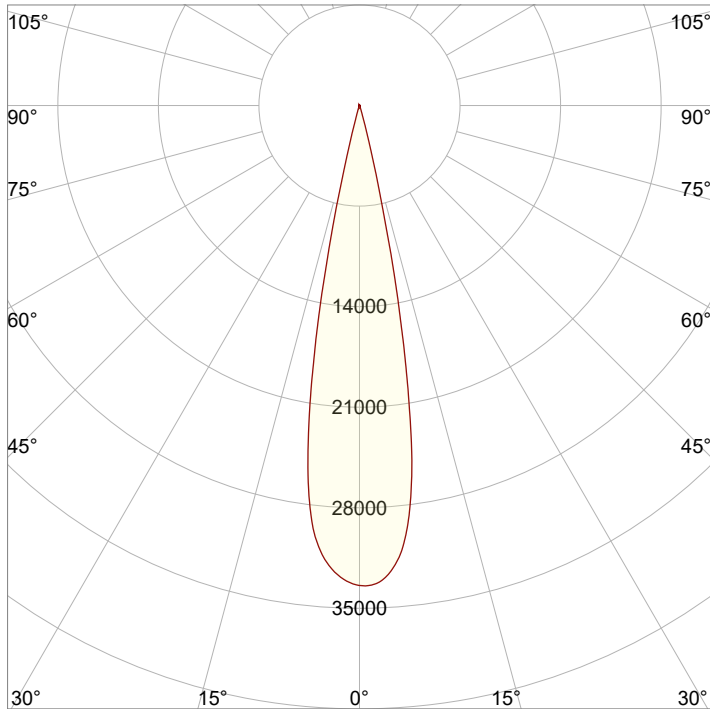

<b>Beam Angle - 50%</b>
<b>21°</b>
<b>Field Angle - 10%</b>
<b>28.3°</b>
<b>Cutoff Angle - 2.5%</b>
<b>32.2°</b>

### ISO Diagrams

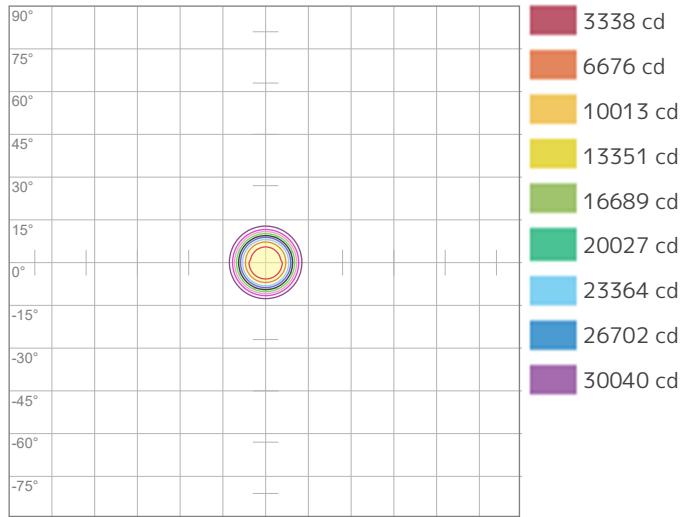

ISO Candela Diagram

Conditions:

Number of c-planes: 2

Candela at center: 33378 cd

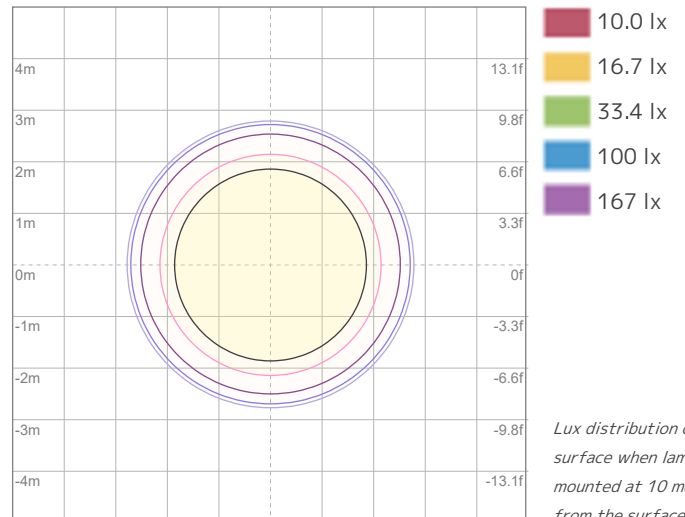

ISO LUX Diagram

Conditions:

Number of c-planes: 2

LUX at center: 334 lx

*Lux distribution on a surface when lamp is mounted at 10 meters from the surface.*

### Linear Distribution

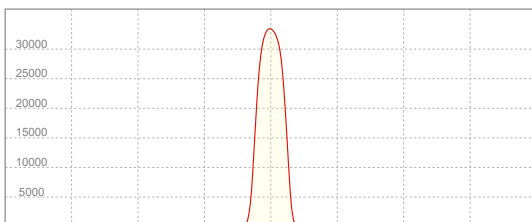

**Peak Candela**  
**33422 cd**

**Calculate Center Beam Intensities**

$$\text{lux} = 33422 / \text{distance(m)}^2$$

$$\text{fc} = 33422 / \text{distance(ft)}^2$$

### Key Measurements

#### Output

Total Lumen Output: 3919 lm  
Peak Intensity: 33577 cd

#### Beam

Beam Angle (50%): 21.3°  
Field Angle (10%): 28.8°  
Cutoff Angle (2.5%): 33.1°

#### Color

Color Temperature: 8568 K  
CRI: 75.9  
TLCI: 69  
TM30 R<sub>F</sub>: 76.3  
TM30 R<sub>g</sub>: 98.4

#### Power Details

Efficacy: 17 Lumen/Watt  
Power: 227.2 W  
Supply Voltage: 119 V  
Current: 1.93 A

### Beam Details

Distance	3 m	5 m	10 m	15 m	20 m
Beam Width	1.1 m	1.9 m	3.8 m	5.6 m	7.5 m

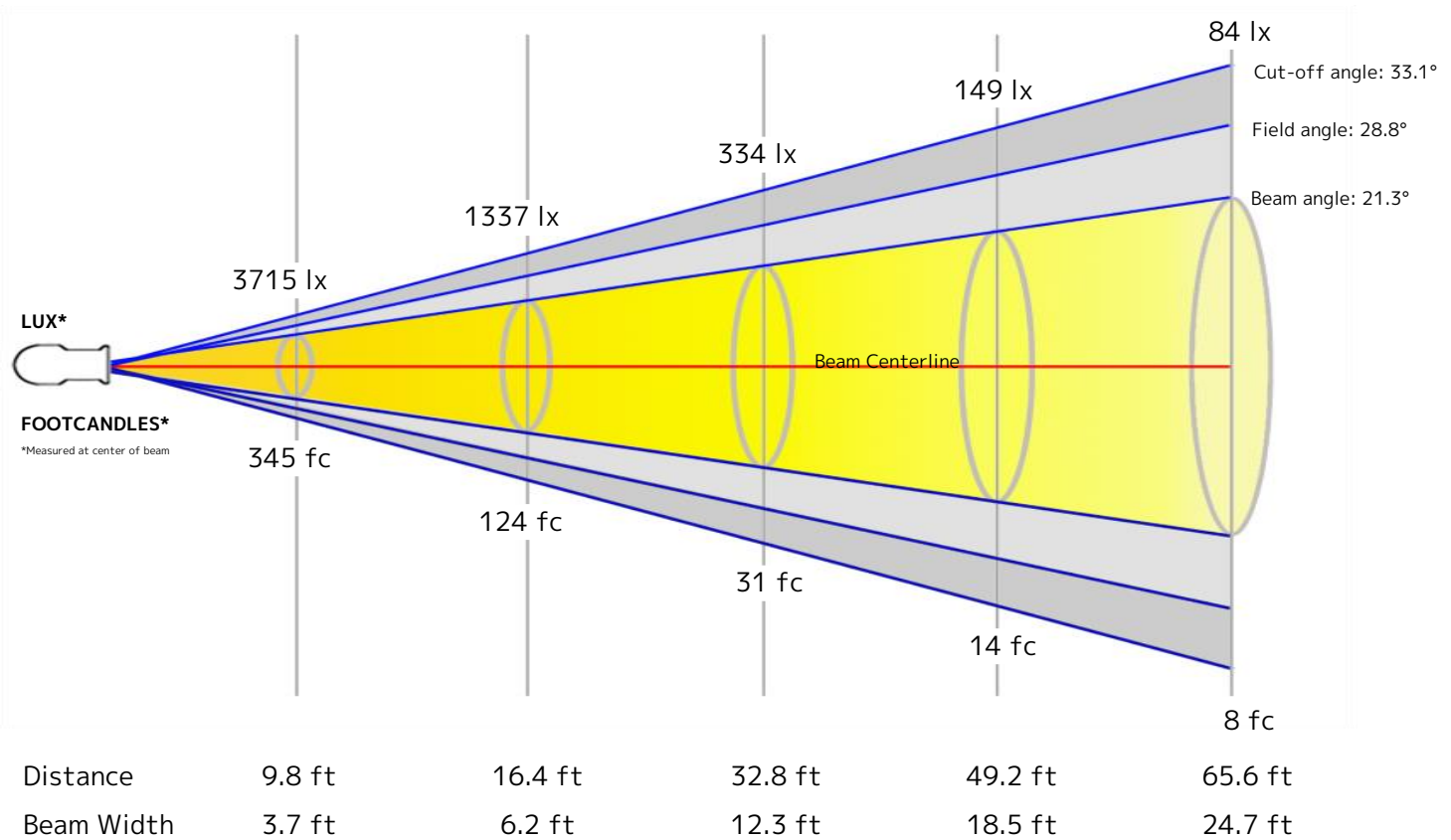

### Beam Intensities from 1-20m

M	1	2	3	4	5	6	7	8	9	10	11	12	13	14	15	16	17	18	19	20
<b>LX</b>	33433	8358	3715	2090	1337	929	682	522	413	334	276	232	198	171	149	131	116	103	93	84
<b>FT</b>	3.3	6.6	9.8	13.1	16.4	19.7	23	26.2	29.5	32.8	36.1	39.4	42.7	45.9	49.2	52.5	55.8	59.1	62.3	65.6
<b>FC</b>	3106	776.5	345.1	194.1	124.2	86.3	63.4	48.5	38.3	31.1	25.7	21.6	18.4	15.8	13.8	12.1	10.7	9.6	8.6	7.8

### Angular Distribution

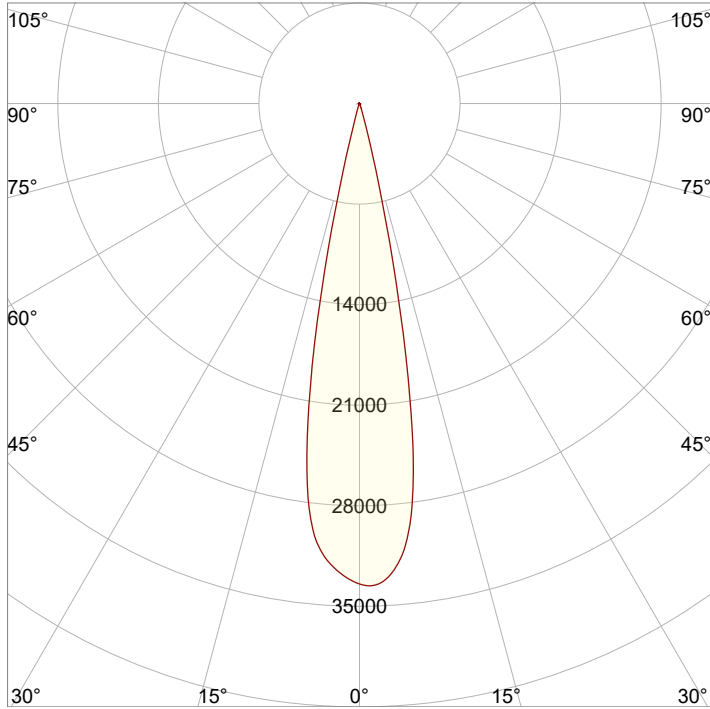

<b>Beam Angle - 50%</b>
<b>21.3°</b>
<b>Field Angle - 10%</b>
<b>28.8°</b>
<b>Cutoff Angle - 2.5%</b>
<b>33.1°</b>

### ISO Diagrams

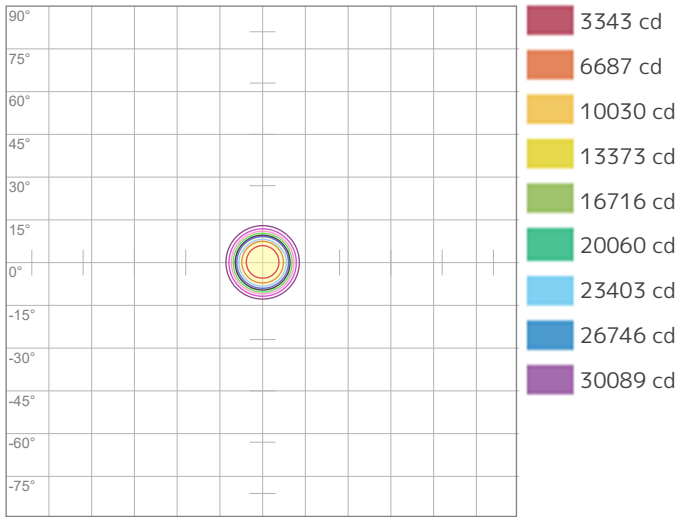

ISO Candela Diagram

Conditions:  
Number of c-planes: 2  
Candela at center: 33433 cd

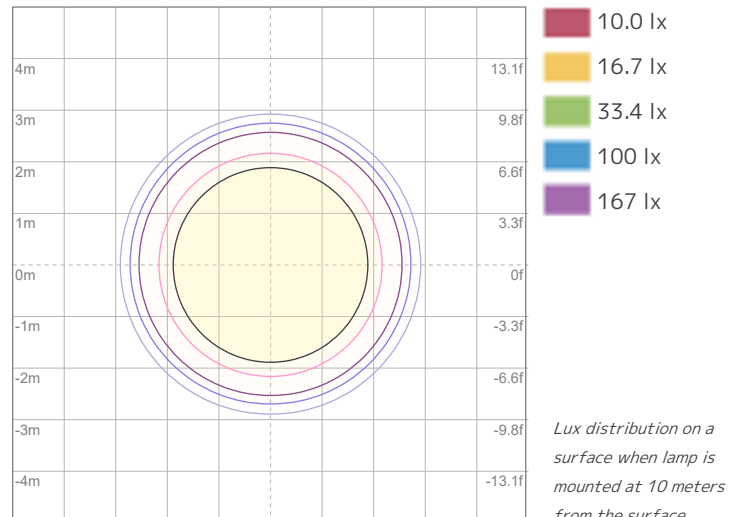

ISO LUX Diagram

Conditions:  
Number of c-planes: 2  
LUX at center: 334 lx

*Lux distribution on a surface when lamp is mounted at 10 meters from the surface.*

### Linear Distribution

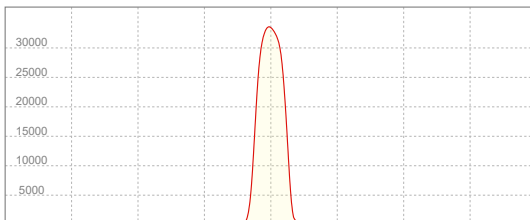

**Peak Candela**  
**33577 cd**

**Calculate Center Beam Intensities**  
 $lux = 33577 / distance(m)^2$   
 $fc = 33577 / distance(ft)^2$

## Key Measurements

### Output

Total Lumen Output: 3714 lm  
Peak Intensity: 7655 cd

### Beam

Beam Angle (50%): 43.1°  
Field Angle (10%): 61.2°  
Cutoff Angle (2.5%): 71.6°

### Color

Color Temperature: 0 K  
CRI: 0.0  
TLCI: n/a  
TM30 R<sub>F</sub>: 0.0  
TM30 R<sub>g</sub>: 0.0

### Power Details

Efficacy: 16 Lumen/Watt  
Power: 232.1 W  
Supply Voltage: 119 V  
Current: 1.96 A

## Beam Details

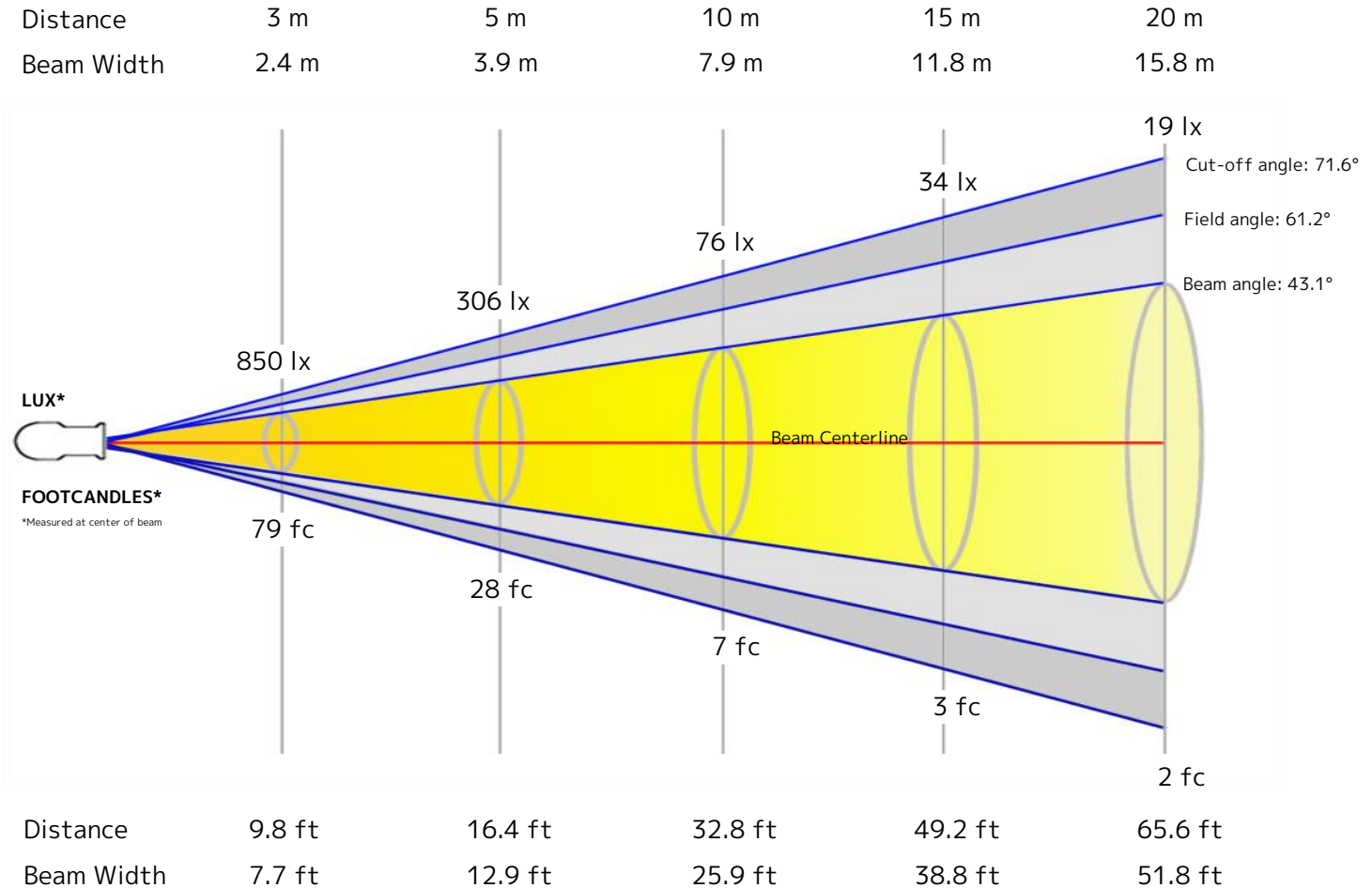

## Beam Intensities from 1-20m

M	1	2	3	4	5	6	7	8	9	10	11	12	13	14	15	16	17	18	19	20
<b>LX</b>	7647	1912	850	478	306	212	156	119	94	76	63	53	45	39	34	30	26	24	21	19
<b>FT</b>	3.3	6.6	9.8	13.1	16.4	19.7	23	26.2	29.5	32.8	36.1	39.4	42.7	45.9	49.2	52.5	55.8	59.1	62.3	65.6
<b>FC</b>	710.4	177.6	78.9	44.4	28.4	19.7	14.5	11.1	8.8	7.1	5.9	4.9	4.2	3.6	3.2	2.8	2.5	2.2	2	1.8

## Angular Distribution

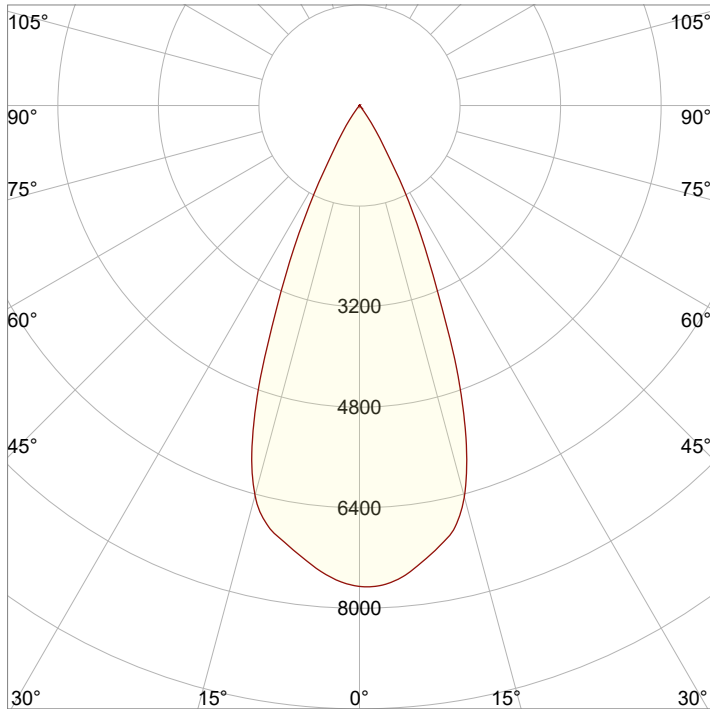

<b>Beam Angle - 50%</b>
<b>43.1°</b>
<b>Field Angle - 10%</b>
<b>61.2°</b>
<b>Cutoff Angle - 2.5%</b>
<b>71.6°</b>

## ISO Diagrams

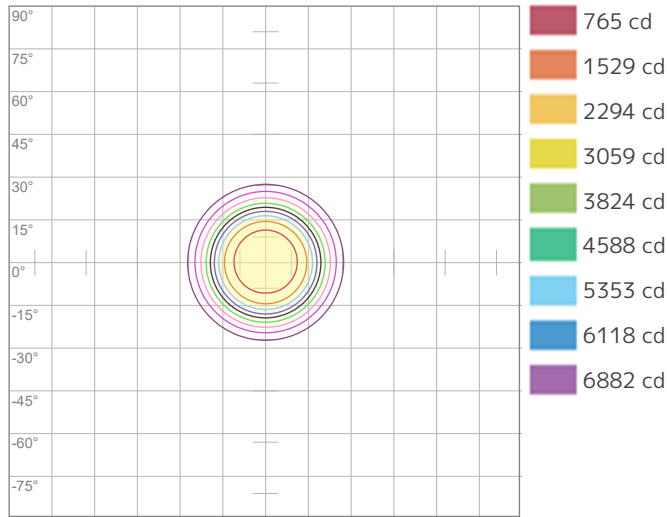

**ISO Candela Diagram**

Conditions:

Number of c-planes: 2

Candela at center: 7647 cd

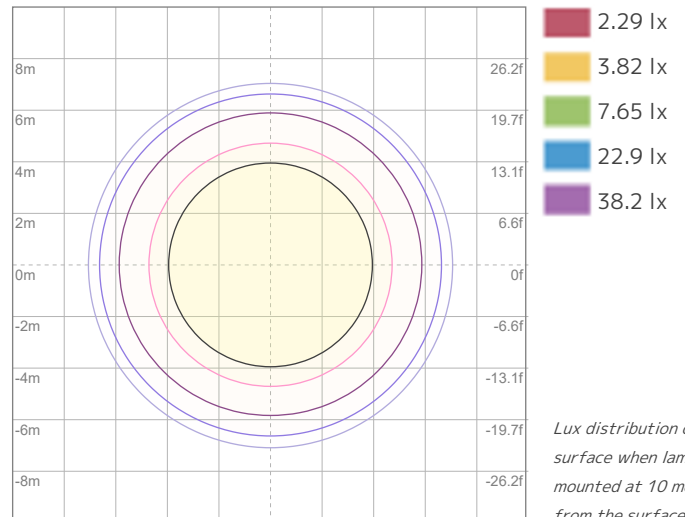

**ISO LUX Diagram**

Conditions:

Number of c-planes: 2

LUX at center: 76.5 lx

*Lux distribution on a surface when lamp is mounted at 10 meters from the surface.*

## Linear Distribution

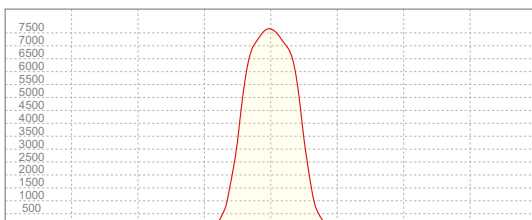

**Peak Candela**  
**7655 cd**

**Calculate Center Beam Intensities**

$$\text{lux} = 7655 / \text{distance(m)}^2$$

$$\text{fc} = 7655 / \text{distance(ft)}^2$$

### Key Measurements

#### Output

Total Lumen Output: 3659 lm  
Peak Intensity: 7465 cd

#### Beam

Beam Angle (50%): 43.7°  
Field Angle (10%): 61.5°  
Cutoff Angle (2.5%): 71.6°

#### Color

Color Temperature: 2358 K  
CRI: 78.7  
TLCI: 56  
TM30 R<sub>F</sub>: 80.7  
TM30 R<sub>G</sub>: 115.8

#### Power Details

Efficacy: 17 Lumen/Watt  
Power: 210 W  
Supply Voltage: 120 V  
Current: 1.76 A

### Beam Details

Distance	3 m	5 m	10 m	15 m	20 m
Beam Width	2.4 m	4 m	8 m	12 m	16 m

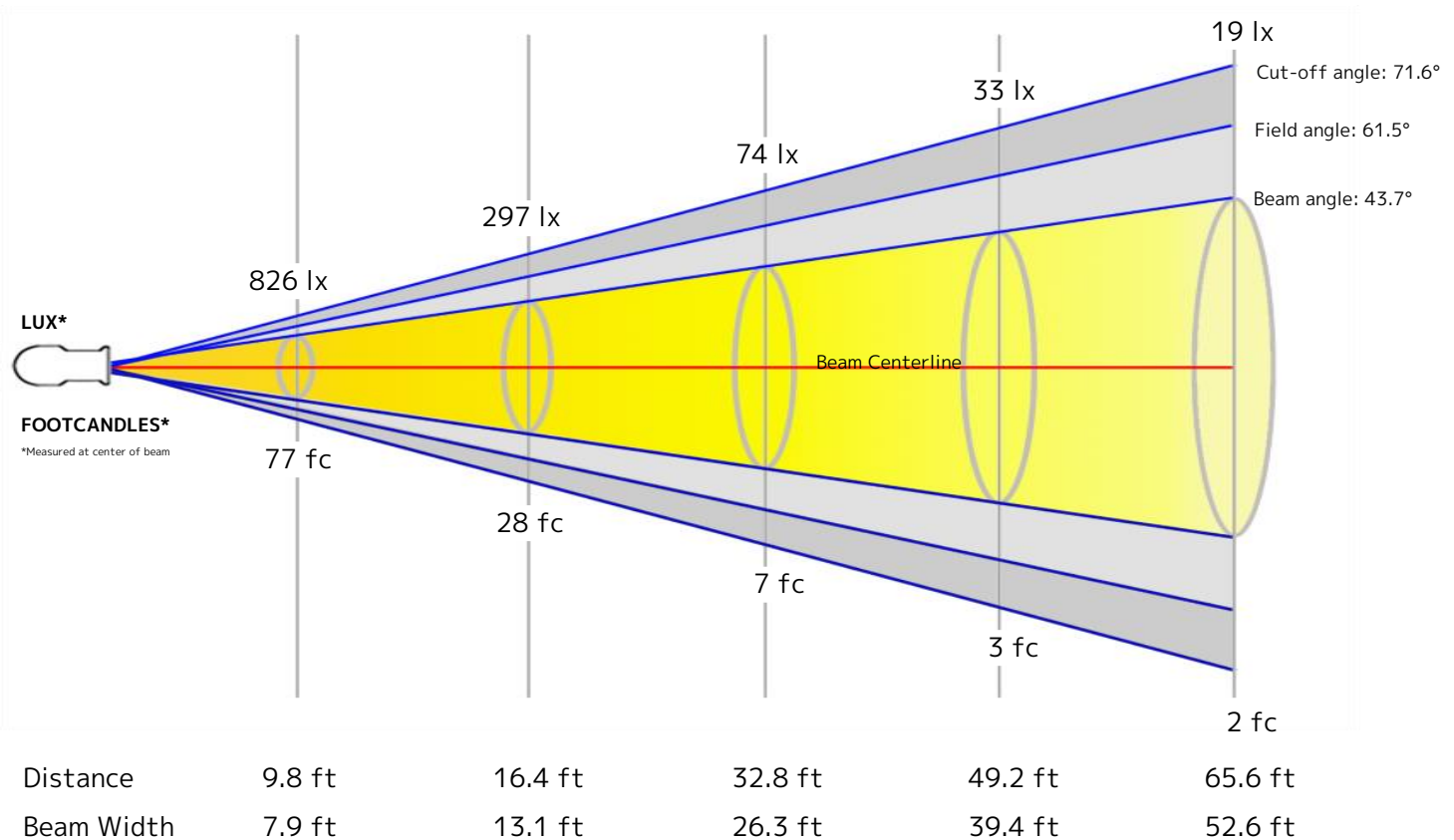

### Beam Intensities from 1-20m

M	1	2	3	4	5	6	7	8	9	10	11	12	13	14	15	16	17	18	19	20
<b>LX</b>	7437	1859	826	465	297	207	152	116	92	74	61	52	44	38	33	29	26	23	21	19
<b>FT</b>	3.3	6.6	9.8	13.1	16.4	19.7	23	26.2	29.5	32.8	36.1	39.4	42.7	45.9	49.2	52.5	55.8	59.1	62.3	65.6
<b>FC</b>	690.9	172.7	76.8	43.2	27.6	19.2	14.1	10.8	8.5	6.9	5.7	4.8	4.1	3.5	3.1	2.7	2.4	2.1	1.9	1.7

### Angular Distribution

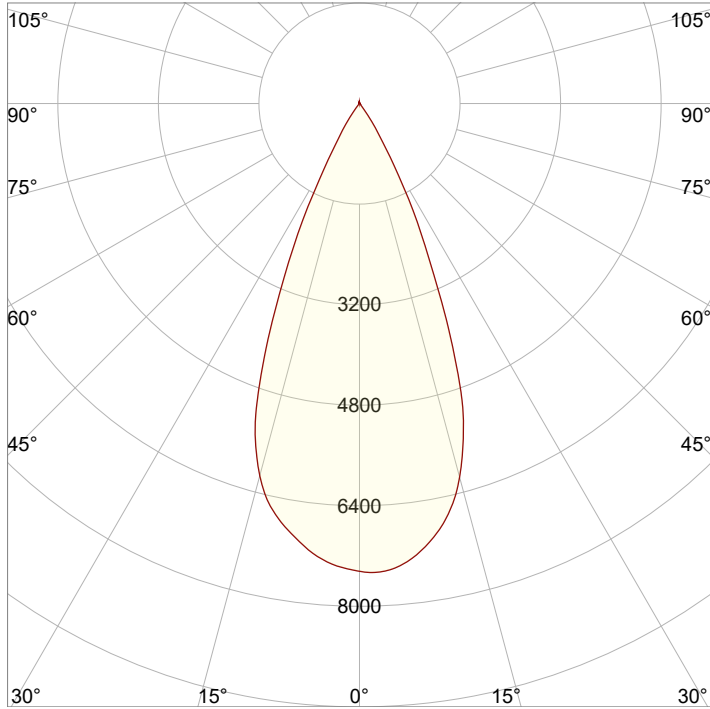

<b>Beam Angle - 50%</b>
<b>43.7°</b>
<b>Field Angle - 10%</b>
<b>61.5°</b>
<b>Cutoff Angle - 2.5%</b>
<b>71.6°</b>

### ISO Diagrams

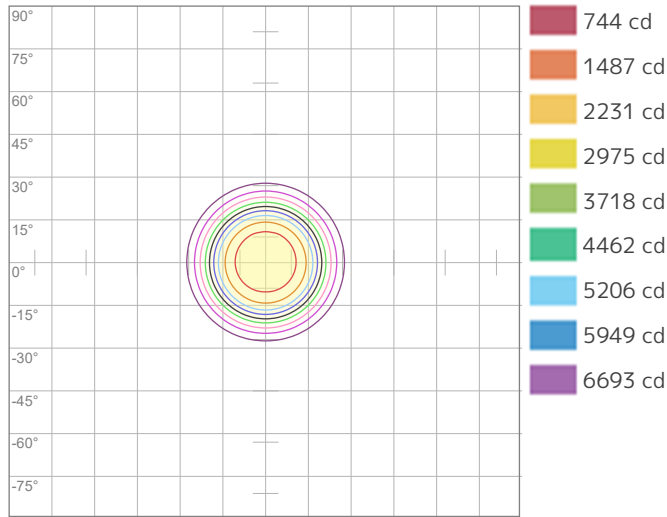

**ISO Candela Diagram**

Conditions:

Number of c-planes: 2

Candela at center: 7437 cd

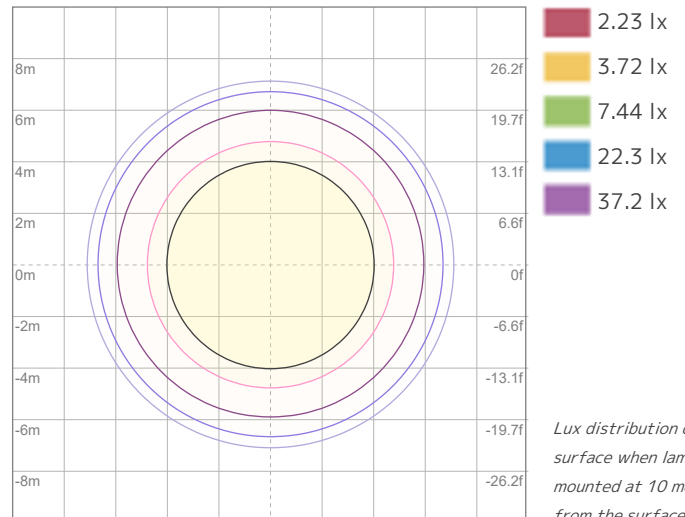

**ISO LUX Diagram**

Conditions:

Number of c-planes: 2

LUX at center: 74.4 lx

*Lux distribution on a surface when lamp is mounted at 10 meters from the surface.*

### Linear Distribution

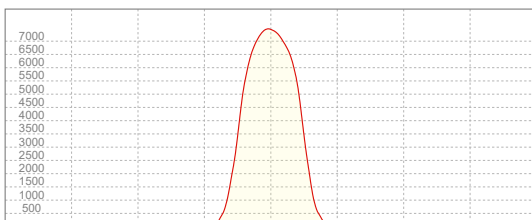

**Peak Candela**  
**7465 cd**

**Calculate Center Beam Intensities**

$$\text{lux} = 7465 / \text{distance(m)}^2$$

$$\text{fc} = 7465 / \text{distance(ft)}^2$$

### Key Measurements

#### Output

Total Lumen Output: 4040 lm  
Peak Intensity: 8006 cd

#### Beam

Beam Angle (50%): 43.6°  
Field Angle (10%): 61.7°  
Cutoff Angle (2.5%): 72.5°

#### Color

Color Temperature: 3203 K  
CRI: 82.7  
TLCI: 73  
TM30 R<sub>F</sub>: 84.3  
TM30 R<sub>G</sub>: 103.1

#### Power Details

Efficacy: 23 Lumen/Watt  
Power: 172 W  
Supply Voltage: 119 V  
Current: 1.46 A

### Beam Details

Distance	3 m	5 m	10 m	15 m	20 m
Beam Width	2.4 m	4 m	8 m	12 m	16 m

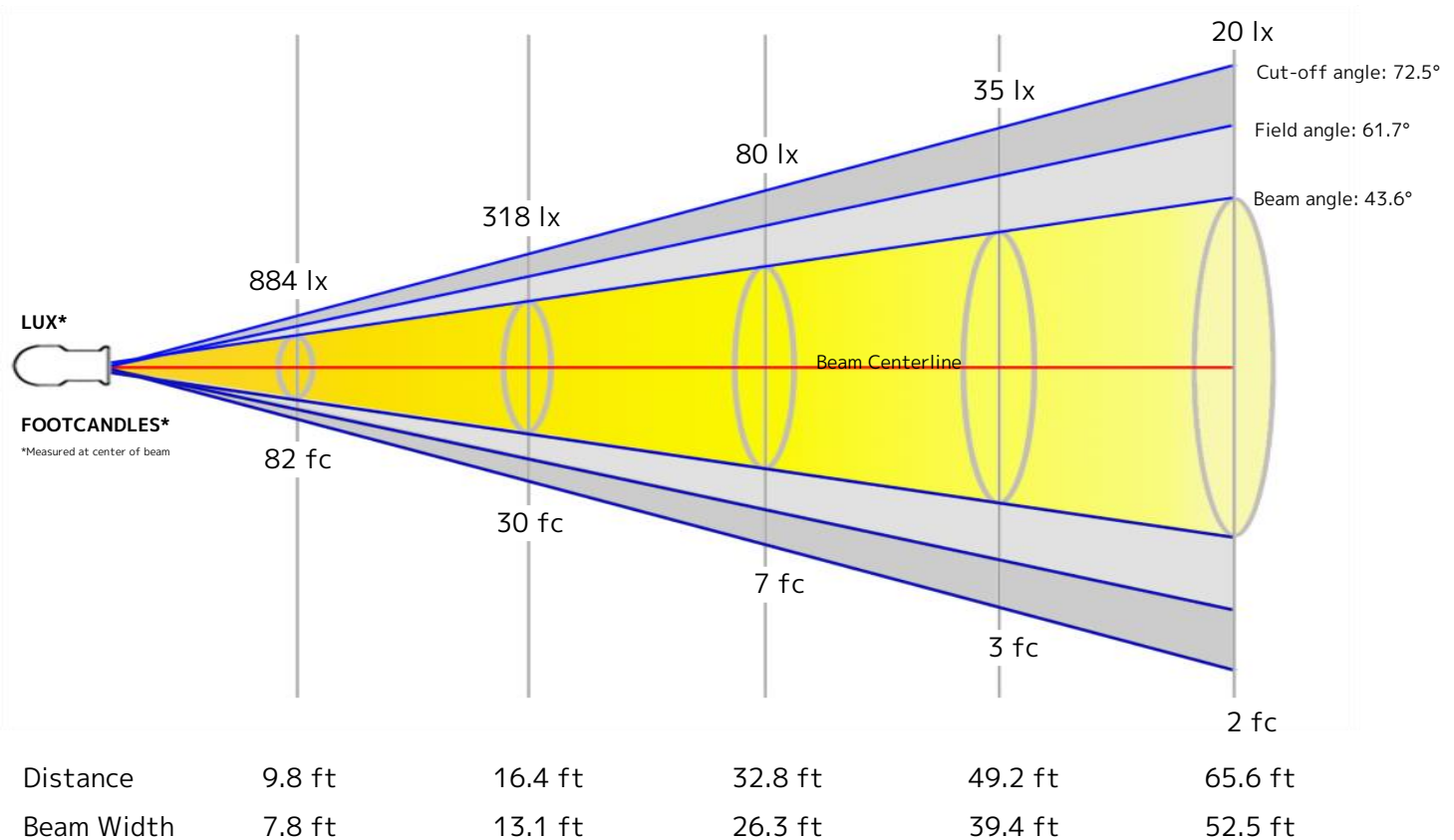

### Beam Intensities from 1-20m

M	1	2	3	4	5	6	7	8	9	10	11	12	13	14	15	16	17	18	19	20
<b>LX</b>	7960	1990	884	498	318	221	162	124	98	80	66	55	47	41	35	31	28	25	22	20
<b>FT</b>	3.3	6.6	9.8	13.1	16.4	19.7	23	26.2	29.5	32.8	36.1	39.4	42.7	45.9	49.2	52.5	55.8	59.1	62.3	65.6
<b>FC</b>	739.5	184.9	82.2	46.2	29.6	20.5	15.1	11.6	9.1	7.4	6.1	5.1	4.4	3.8	3.3	2.9	2.6	2.3	2	1.8

### Angular Distribution

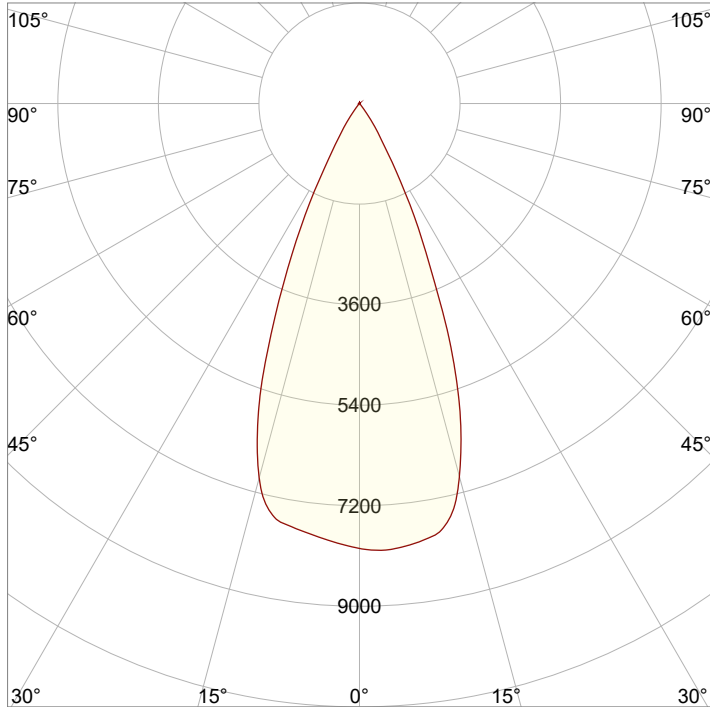

<b>Beam Angle - 50%</b>
<b>43.6°</b>
<b>Field Angle - 10%</b>
<b>61.7°</b>
<b>Cutoff Angle - 2.5%</b>
<b>72.5°</b>

### ISO Diagrams

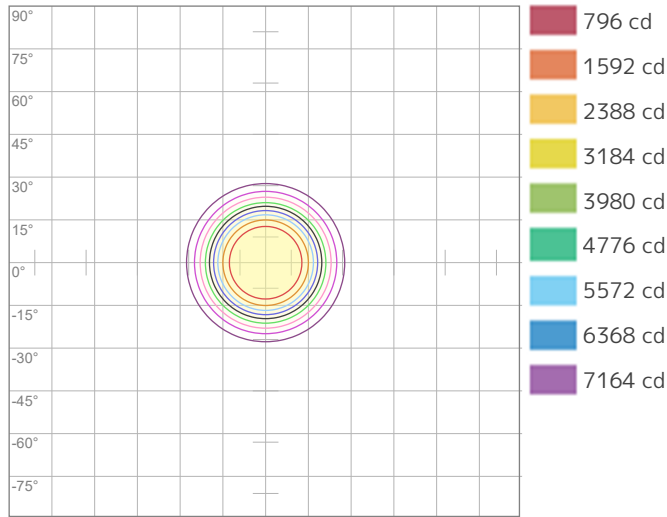

ISO Candela Diagram

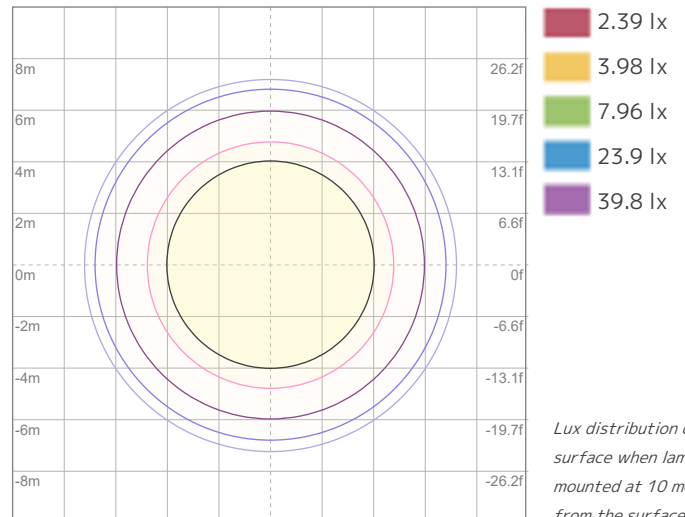

ISO LUX Diagram

*Lux distribution on a surface when lamp is mounted at 10 meters from the surface.*

Conditions:

Number of c-planes: 2  
Candela at center: 7960 cd

Conditions:

Number of c-planes: 2  
LUX at center: 79.6 lx

### Linear Distribution

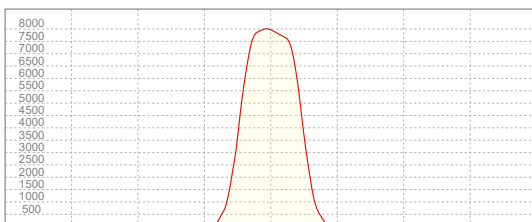

**Peak Candela**  
**8006 cd**

**Calculate Center Beam Intensities**

$$\text{lux} = 8006 / \text{distance(m)}^2$$

$$\text{fc} = 8006 / \text{distance(ft)}^2$$

### Key Measurements

#### Output

Total Lumen Output: 4334 lm  
Peak Intensity: 8558 cd

#### Beam

Beam Angle (50%): 43.6°  
Field Angle (10%): 61.9°  
Cutoff Angle (2.5%): 73°

#### Color

Color Temperature: 4497 K  
CRI: 73.6  
TLCI: 60  
TM30 R<sub>F</sub>: 75.6  
TM30 R<sub>g</sub>: 98.6

#### Power Details

Efficacy: 25 Lumen/Watt  
Power: 175.2 W  
Supply Voltage: 120 V  
Current: 1.47 A

### Beam Details

Distance	3 m	5 m	10 m	15 m	20 m
Beam Width	2.4 m	4 m	8 m	12 m	16 m

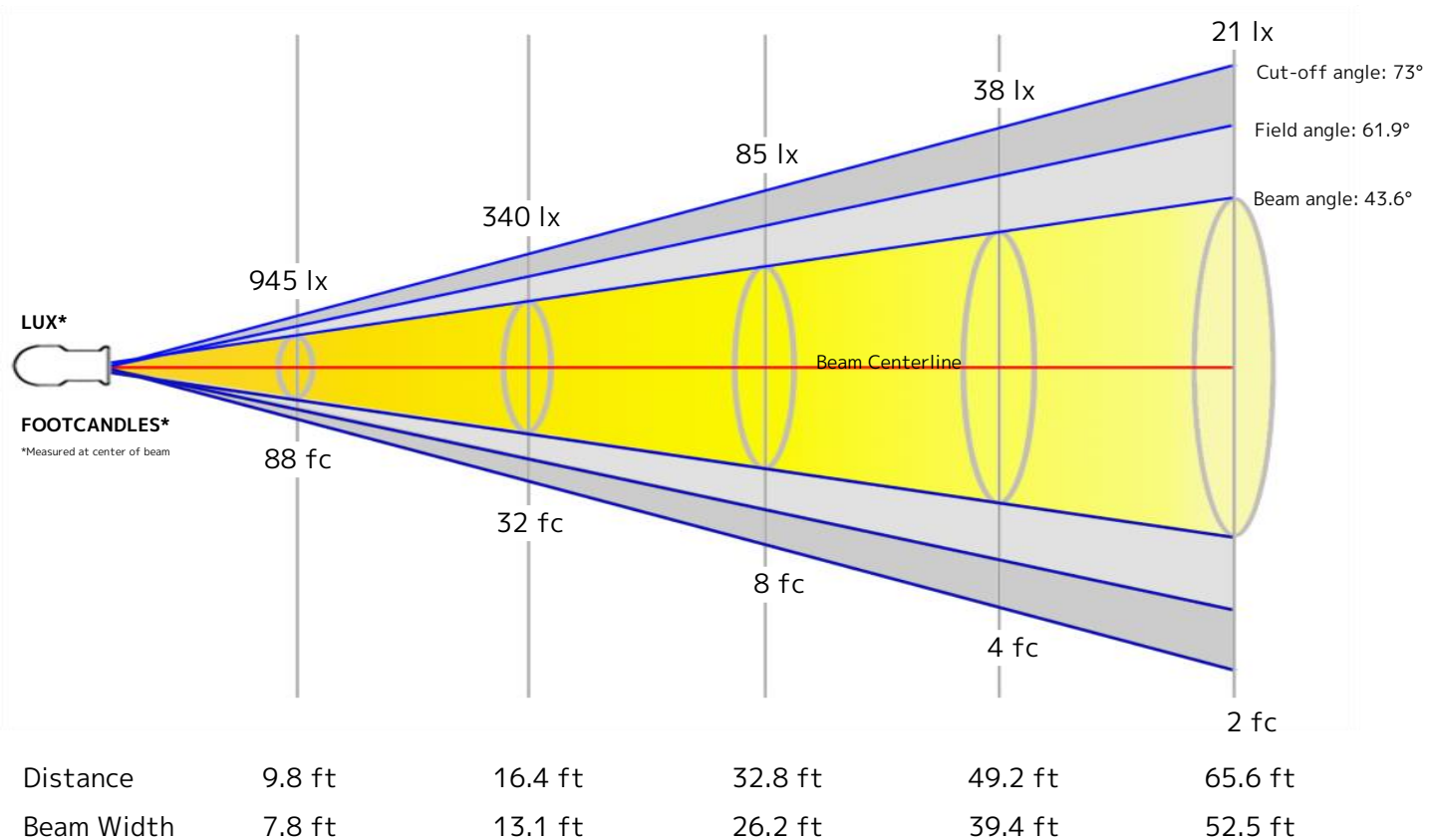

### Beam Intensities from 1-20m

M	1	2	3	4	5	6	7	8	9	10	11	12	13	14	15	16	17	18	19	20
<b>LX</b>	8509	2127	945	532	340	236	174	133	105	85	70	59	50	43	38	33	29	26	24	21
<b>FT</b>	3.3	6.6	9.8	13.1	16.4	19.7	23	26.2	29.5	32.8	36.1	39.4	42.7	45.9	49.2	52.5	55.8	59.1	62.3	65.6
<b>FC</b>	790.5	197.6	87.8	49.4	31.6	22	16.1	12.4	9.8	7.9	6.5	5.5	4.7	4	3.5	3.1	2.7	2.4	2.2	2

### Angular Distribution

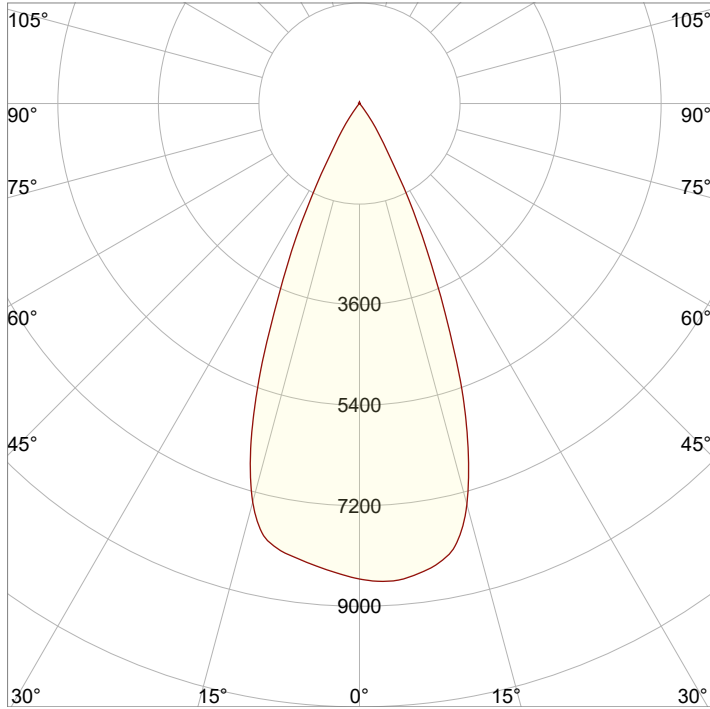

<b>Beam Angle - 50%</b>
<b>43.6°</b>
<b>Field Angle - 10%</b>
<b>61.9°</b>
<b>Cutoff Angle - 2.5%</b>
<b>73°</b>

### ISO Diagrams

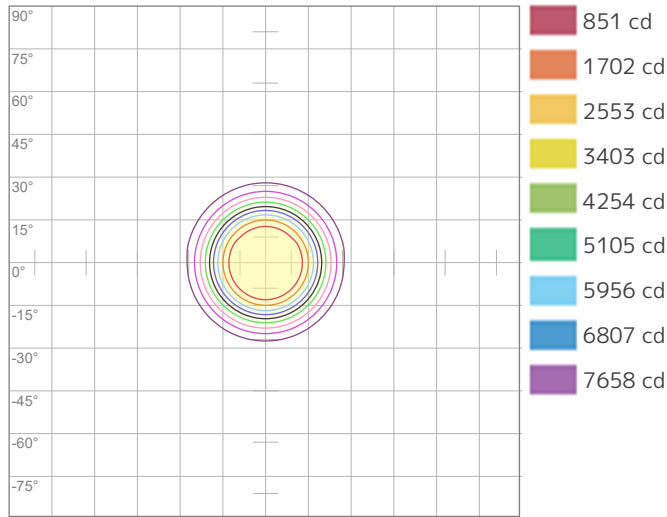

ISO Candela Diagram

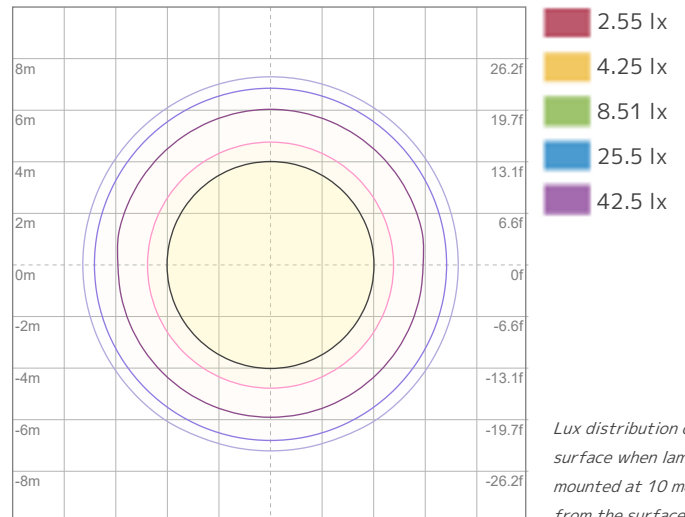

ISO LUX Diagram

*Lux distribution on a surface when lamp is mounted at 10 meters from the surface.*

Conditions:

Number of c-planes: 2  
Candela at center: 8509 cd

Conditions:

Number of c-planes: 2  
LUX at center: 85.1 lx

### Linear Distribution

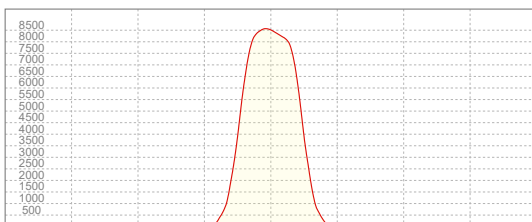

**Peak Candela**  
**8558 cd**

**Calculate Center Beam Intensities**

$lux = 8558 / distance(m)^2$   
 $fc = 8558 / distance(ft)^2$

### Key Measurements

#### Output

Total Lumen Output: 4786 lm  
Peak Intensity: 10004 cd

#### Beam

Beam Angle (50%): 42.7°  
Field Angle (10%): 61.1°  
Cutoff Angle (2.5%): 71.2°

#### Color

Color Temperature: 5591 K  
CRI: 73.8  
TLCI: 65  
TM30 R<sub>F</sub>: 75.5  
TM30 R<sub>g</sub>: 99.1

#### Power Details

Efficacy: 25 Lumen/Watt  
Power: 193.8 W  
Supply Voltage: 119 V  
Current: 1.64 A

### Beam Details

Distance	3 m	5 m	10 m	15 m	20 m
Beam Width	2.3 m	3.9 m	7.8 m	11.7 m	15.6 m

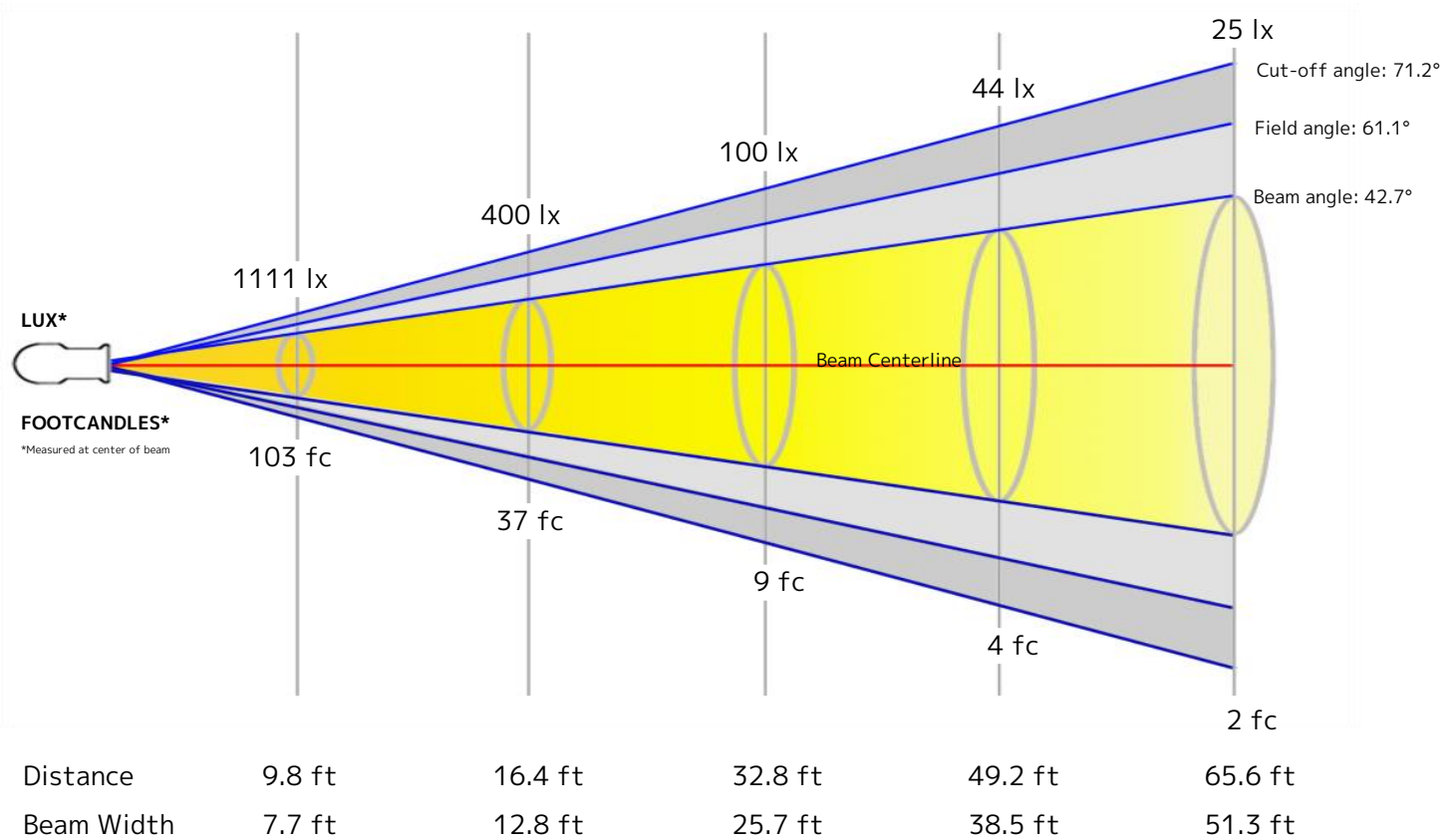

### Beam Intensities from 1-20m

M	1	2	3	4	5	6	7	8	9	10	11	12	13	14	15	16	17	18	19	20
<b>LX</b>	9998	2500	1111	625	400	278	204	156	123	100	83	69	59	51	44	39	35	31	28	25
<b>FT</b>	3.3	6.6	9.8	13.1	16.4	19.7	23	26.2	29.5	32.8	36.1	39.4	42.7	45.9	49.2	52.5	55.8	59.1	62.3	65.6
<b>FC</b>	928.9	232.2	103.2	58.1	37.2	25.8	19	14.5	11.5	9.3	7.7	6.5	5.5	4.7	4.1	3.6	3.2	2.9	2.6	2.3

### Angular Distribution

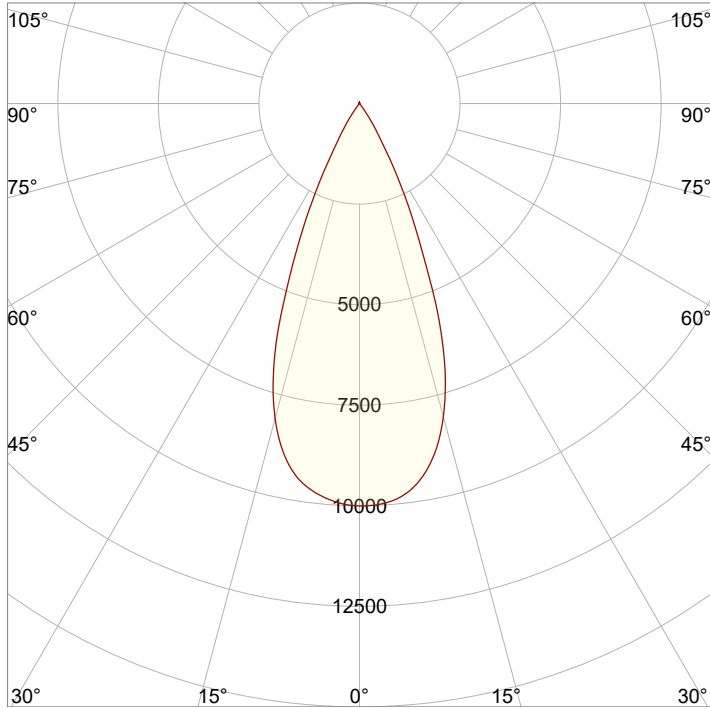

<b>Beam Angle - 50%</b>
<b>42.7°</b>
<b>Field Angle - 10%</b>
<b>61.1°</b>
<b>Cutoff Angle - 2.5%</b>
<b>71.2°</b>

### ISO Diagrams

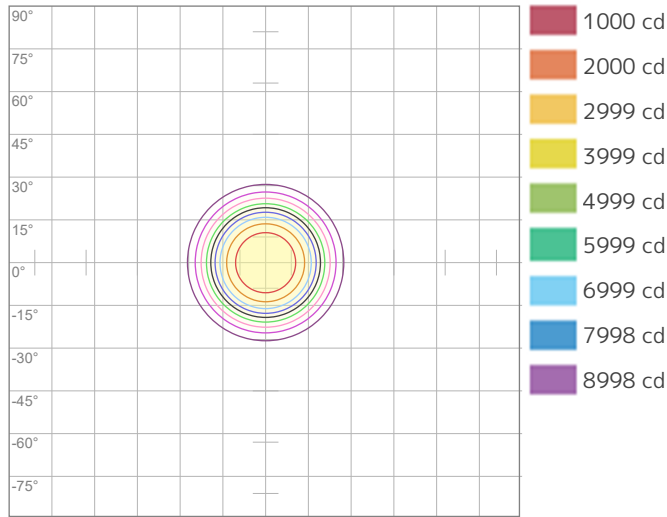

ISO Candela Diagram

Conditions:

Number of c-planes: 2

Candela at center: 9998 cd

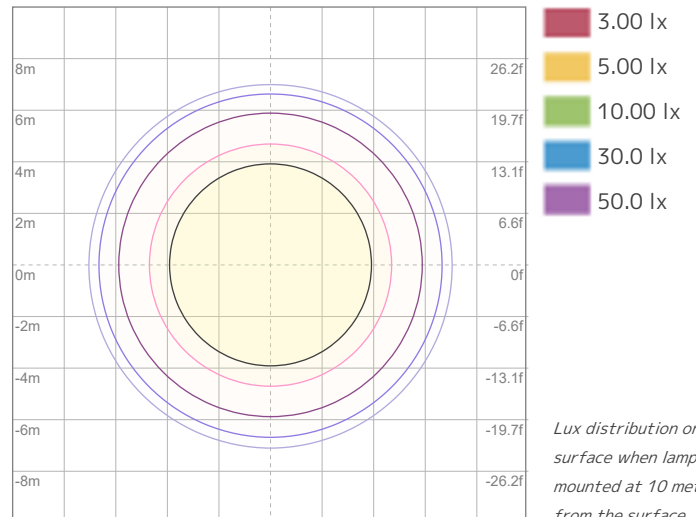

ISO LUX Diagram

*Lux distribution on a surface when lamp is mounted at 10 meters from the surface.*

Conditions:

Number of c-planes: 2

LUX at center: 100.0 lx

### Linear Distribution

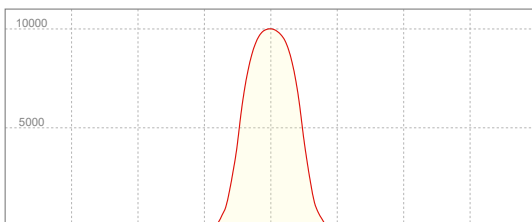

**Peak Candela**  
**10004 cd**

**Calculate Center Beam Intensities**

$$\text{lux} = 10004 / \text{distance(m)}^2$$

$$\text{fc} = 10004 / \text{distance(ft)}^2$$

### Key Measurements

#### Output

Total Lumen Output: 4844 lm  
Peak Intensity: 9874 cd

#### Beam

Beam Angle (50%): 43°  
Field Angle (10%): 62.2°  
Cutoff Angle (2.5%): 72.6°

#### Color

Color Temperature: 6448 K  
CRI: 75.1  
TLCI: 68  
TM30 R<sub>F</sub>: 76.2  
TM30 R<sub>g</sub>: 99.0

#### Power Details

Efficacy: 24 Lumen/Watt  
Power: 206 W  
Supply Voltage: 119 V  
Current: 1.74 A

### Beam Details

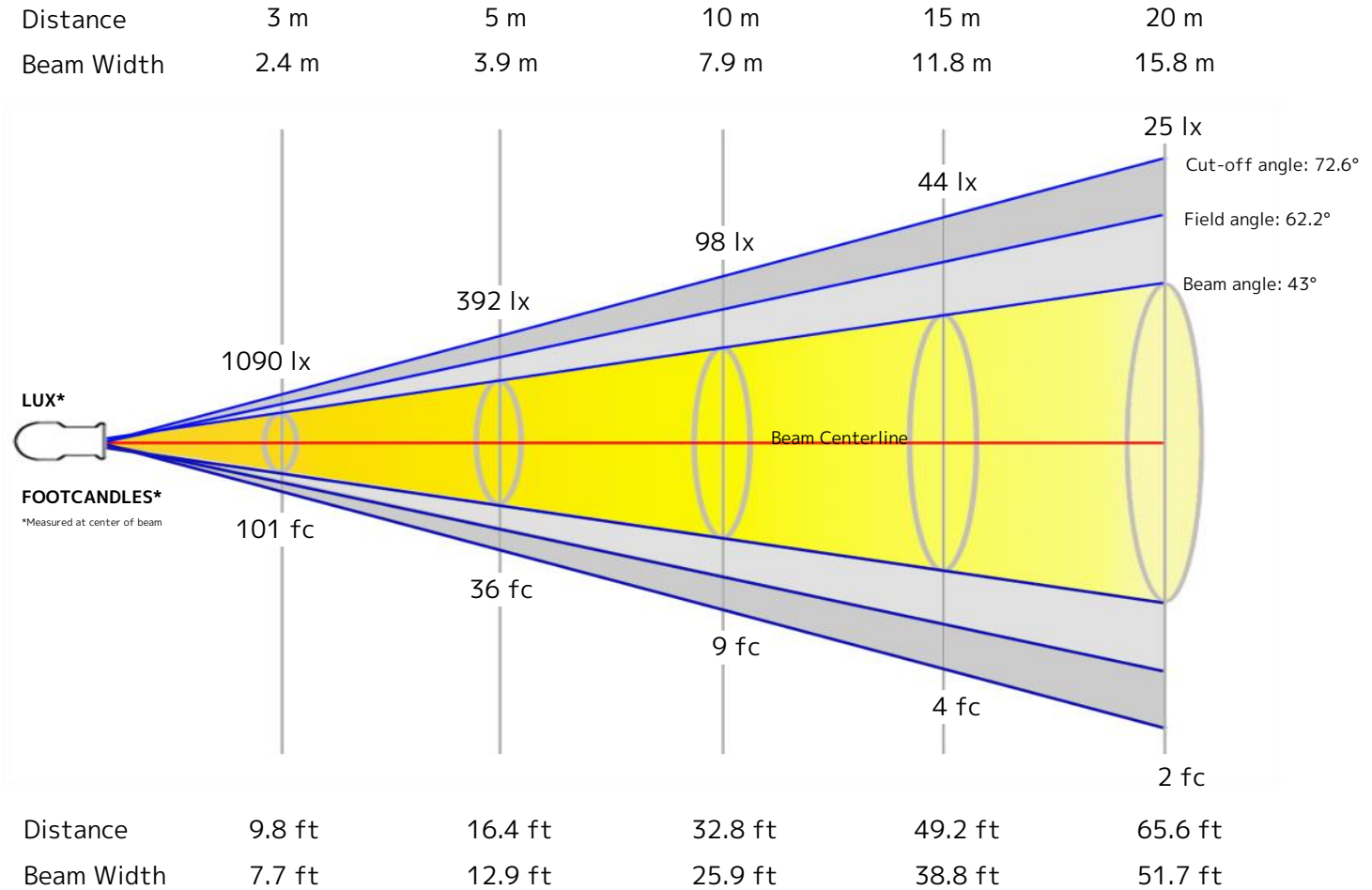

### Beam Intensities from 1-20m

M	1	2	3	4	5	6	7	8	9	10	11	12	13	14	15	16	17	18	19	20
<b>LX</b>	9809	2452	1090	613	392	272	200	153	121	98	81	68	58	50	44	38	34	30	27	25
<b>FT</b>	3.3	6.6	9.8	13.1	16.4	19.7	23	26.2	29.5	32.8	36.1	39.4	42.7	45.9	49.2	52.5	55.8	59.1	62.3	65.6
<b>FC</b>	911.3	227.8	101.3	57	36.5	25.3	18.6	14.2	11.3	9.1	7.5	6.3	5.4	4.6	4.1	3.6	3.2	2.8	2.5	2.3

### Angular Distribution

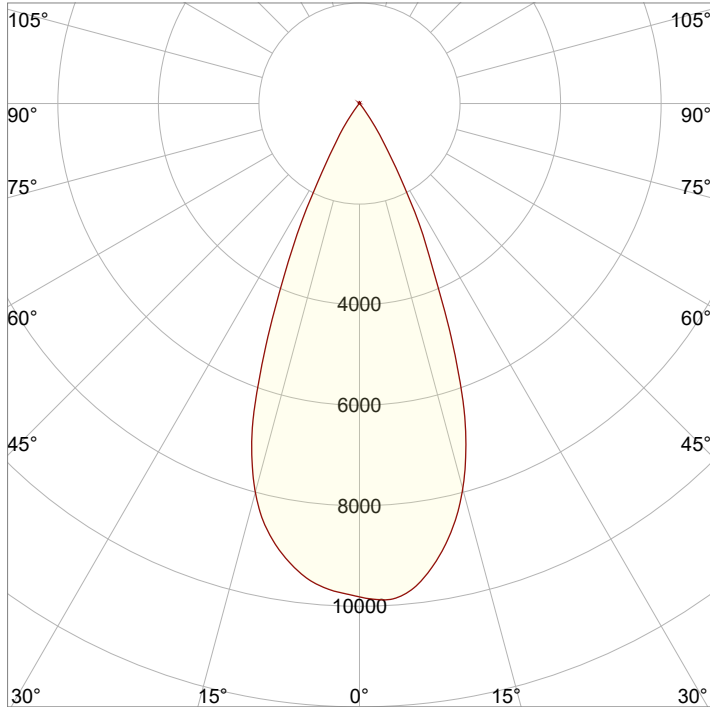

<b>Beam Angle - 50%</b>
<b>43°</b>
<b>Field Angle - 10%</b>
<b>62.2°</b>
<b>Cutoff Angle - 2.5%</b>
<b>72.6°</b>

### ISO Diagrams

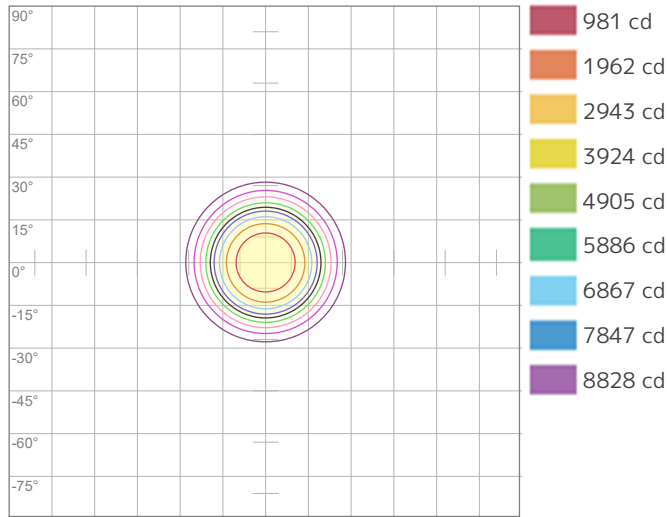

ISO Candela Diagram

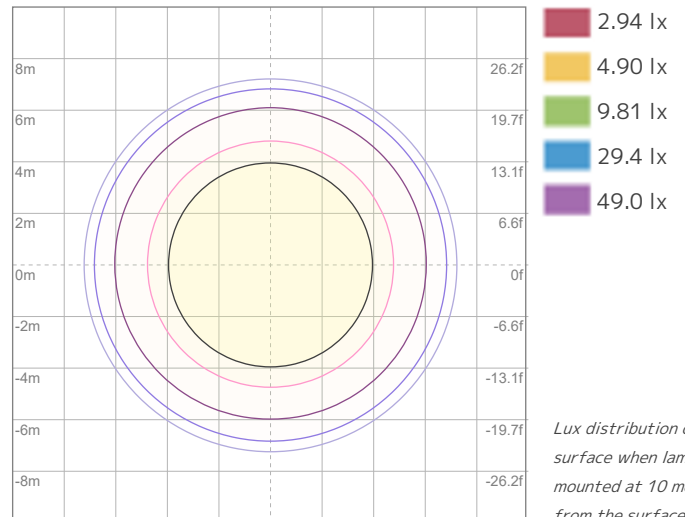

ISO LUX Diagram

*Lux distribution on a surface when lamp is mounted at 10 meters from the surface.*

Conditions:

Number of c-planes: 2  
Candela at center: 9809 cd

Conditions:

Number of c-planes: 2  
LUX at center: 98.1 lx

### Linear Distribution

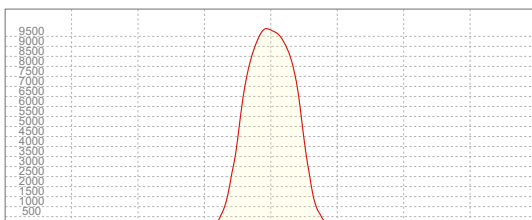

**Peak Candela**  
**9874 cd**

**Calculate Center Beam Intensities**

$$\text{lux} = 9874 / \text{distance(m)}^2$$

$$\text{fc} = 9874 / \text{distance(ft)}^2$$

### Key Measurements

#### Output

Total Lumen Output: 4773 lm  
Peak Intensity: 9877 cd

#### Beam

Beam Angle (50%): 43.2°  
Field Angle (10%): 61.9°  
Cutoff Angle (2.5%): 72.1°

#### Color

Color Temperature: 8235 K  
CRI: 75.7  
TLCI: 69  
TM30 R<sub>F</sub>: 76.4  
TM30 R<sub>g</sub>: 97.8

#### Power Details

Efficacy: 21 Lumen/Watt  
Power: 225.1 W  
Supply Voltage: 119 V  
Current: 1.90 A

### Beam Details

Distance	3 m	5 m	10 m	15 m	20 m
Beam Width	2.4 m	4 m	7.9 m	11.9 m	15.8 m

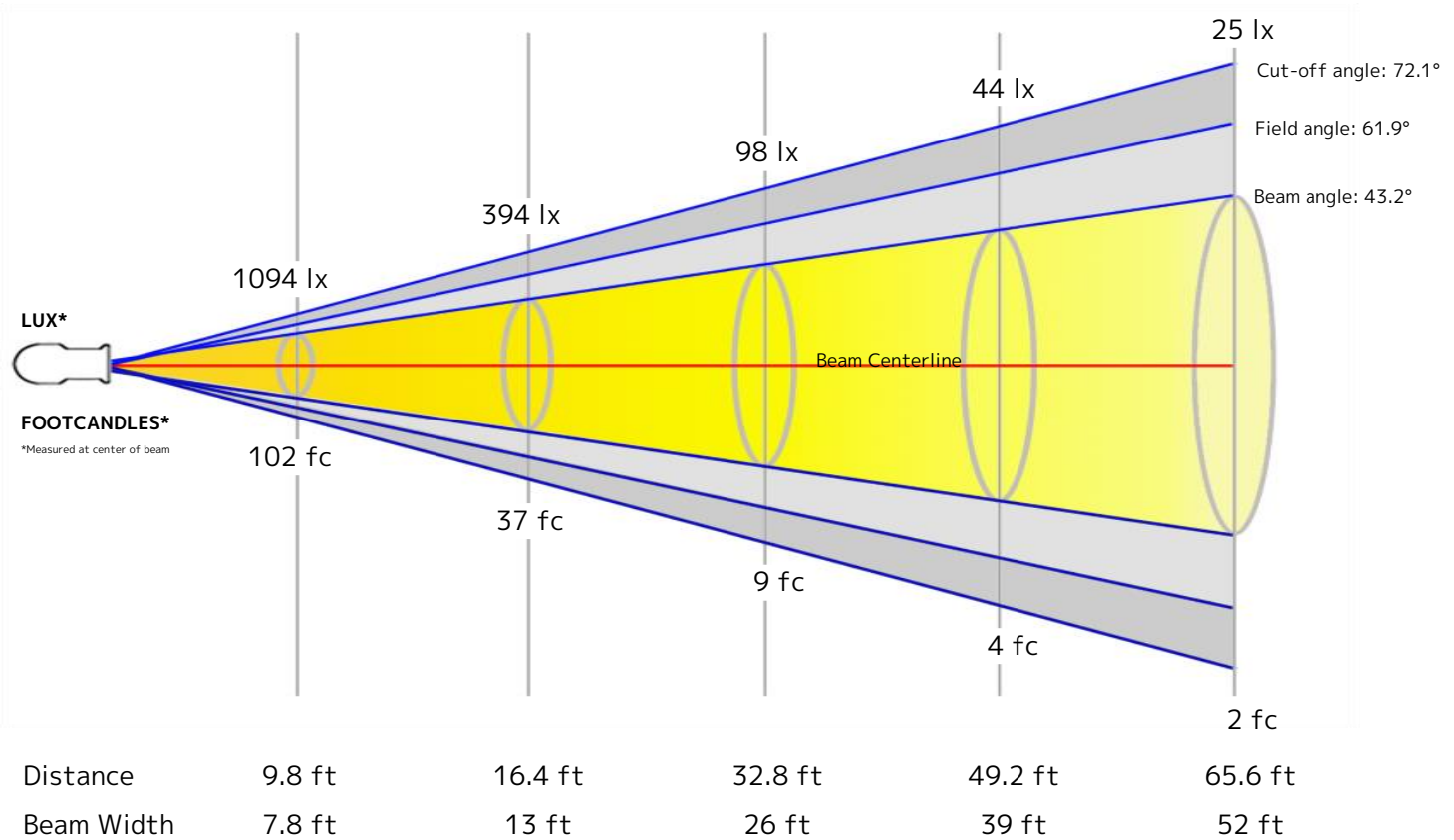

### Beam Intensities from 1-20m

M	1	2	3	4	5	6	7	8	9	10	11	12	13	14	15	16	17	18	19	20
<b>LX</b>	9844	2461	1094	615	394	273	201	154	122	98	81	68	58	50	44	38	34	30	27	25
<b>FT</b>	3.3	6.6	9.8	13.1	16.4	19.7	23	26.2	29.5	32.8	36.1	39.4	42.7	45.9	49.2	52.5	55.8	59.1	62.3	65.6
<b>FC</b>	914.5	228.6	101.6	57.2	36.6	25.4	18.7	14.3	11.3	9.1	7.6	6.4	5.4	4.7	4.1	3.6	3.2	2.8	2.5	2.3

### Angular Distribution

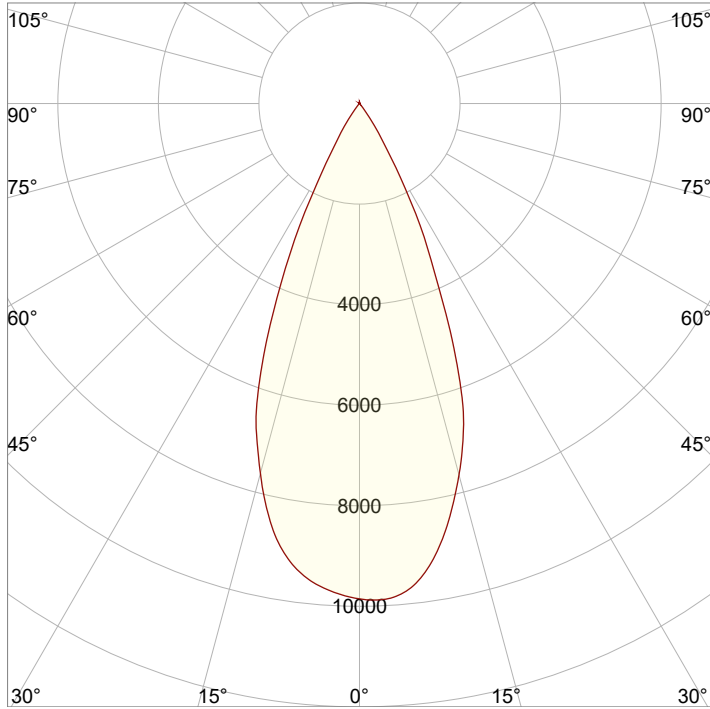

<b>Beam Angle - 50%</b>
<b>43.2°</b>
<b>Field Angle - 10%</b>
<b>61.9°</b>
<b>Cutoff Angle - 2.5%</b>
<b>72.1°</b>

### ISO Diagrams

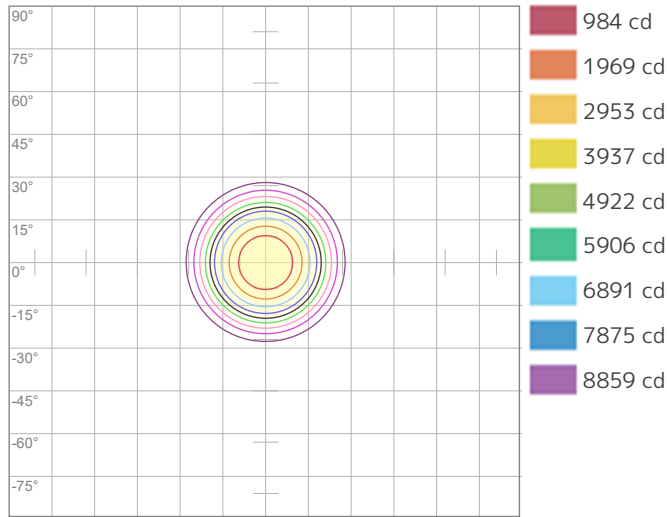

ISO Candela Diagram

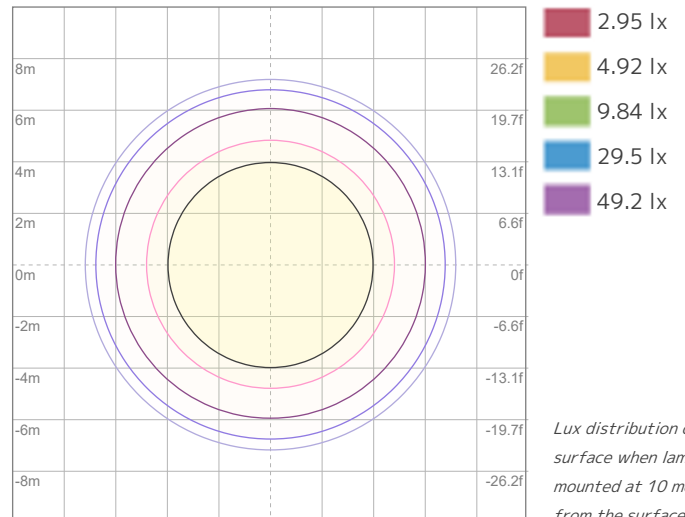

ISO LUX Diagram

*Lux distribution on a surface when lamp is mounted at 10 meters from the surface.*

Conditions:

Number of c-planes: 2

Candela at center: 9844 cd

Conditions:

Number of c-planes: 2

LUX at center: 98.4 lx

### Linear Distribution

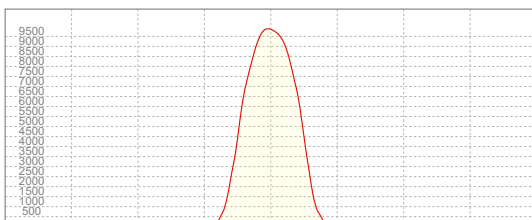

**Peak Candela**

**9877 cd**

**Calculate Center Beam Intensities**

$$\text{lux} = 9877 / \text{distance(m)}^2$$

$$\text{fc} = 9877 / \text{distance(ft)}^2$$

### Color Temperature: 0K

#### Accuracy Metric Overview

Color Rendering Index	Color Rendering Index, R9 (Red Component)	TM-30 Color Fidelity	TM-30 Color Gamut	Television Lighting Consistency Index	Color Quality Scale	Color Coordinate- CIE 1931	Color Coordinate- CIE 1931	Deviation from Black Body Locus	SSI [CIE A] Tungsten	SSI [CIE D65] Daylight
CRI	CRI R9	TM30 R <sub>f</sub>	TM30 R <sub>g</sub>	TLCI	CQS	x	Y	Δuv	SSIt	SSId
0.0	0.0	0.0	0.0	n/a	0.0	0.259	0.227	n/a	-28	30

CIE 1931

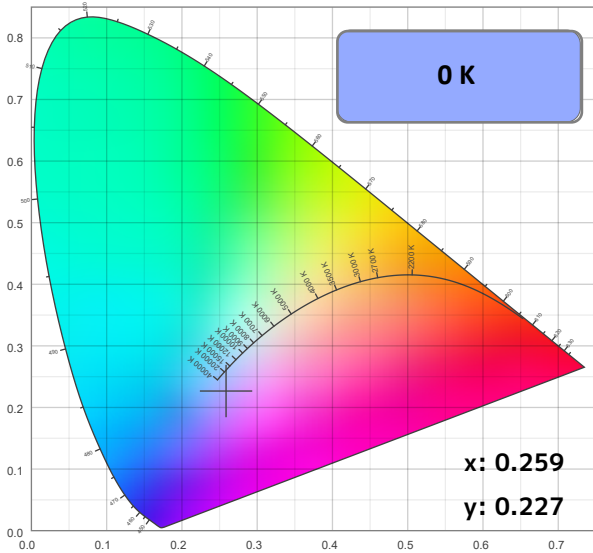

CIE 1931 ZOOMED

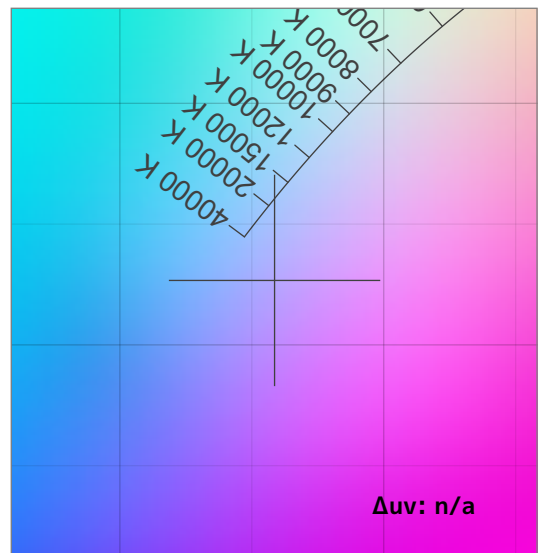

#### CRI: 0.0 (R1-R8)

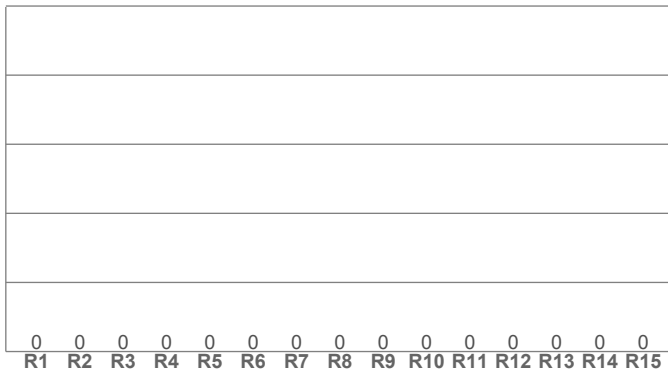

#### Spectral Power Distribution (SPD)

Dominant Wavelength 455 nm

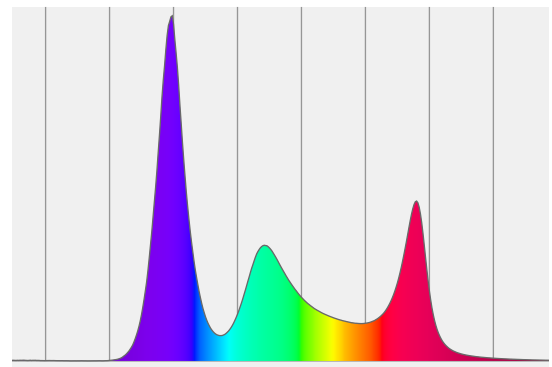

#### SSI Spectral Variance Graph- Tungsten

SSI [CIE A] -28

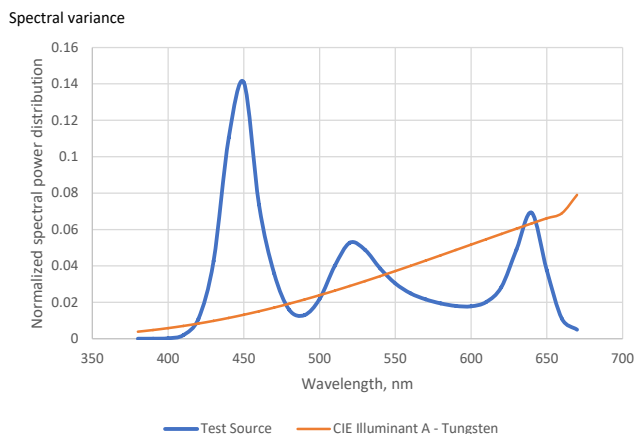

#### SSI Spectral Variance Graph- Daylight

SSI [CIE D65] 30

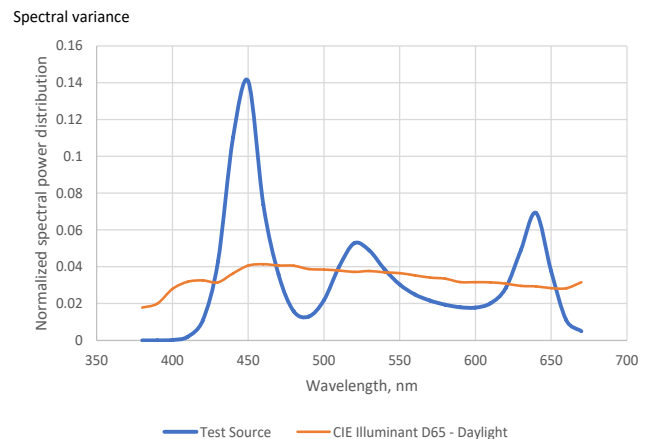



### Color Temperature: 2350K

#### Accuracy Metric Overview

Color Rendering Index	Color Rendering Index, R9 (Red Component)	TM-30 Color Fidelity	TM-30 Color Gamut	Television Lighting Consistency Index	Color Quality Scale	Color Coordinate- CIE 1931	Color Coordinate- CIE 1931	Deviation from Black Body Locus	SSI [CIE A] Tungsten	SSI [CIE D65] Daylight
CRI	CRI R9	TM30 R <sub>f</sub>	TM30 R <sub>g</sub>	TLCI	CQS	x	Y	Δuv	SSIt	SSId
78.6	24.8	80.5	116.1	56	80.2	0.490	0.414	-0.0004	48	-11

**CIE 1931**

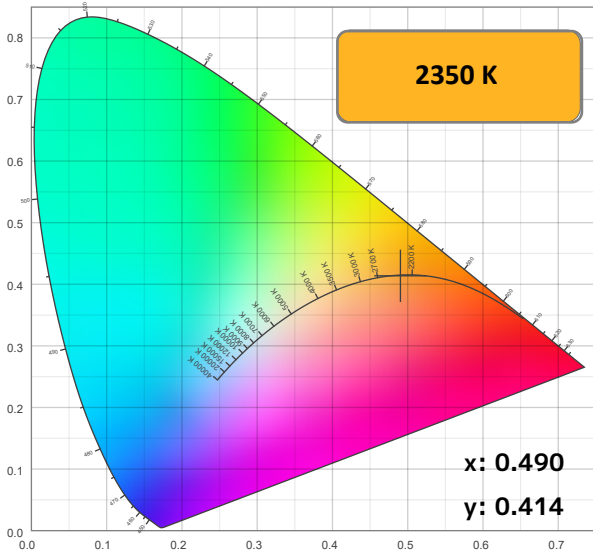

**CIE 1931 ZOOMED**

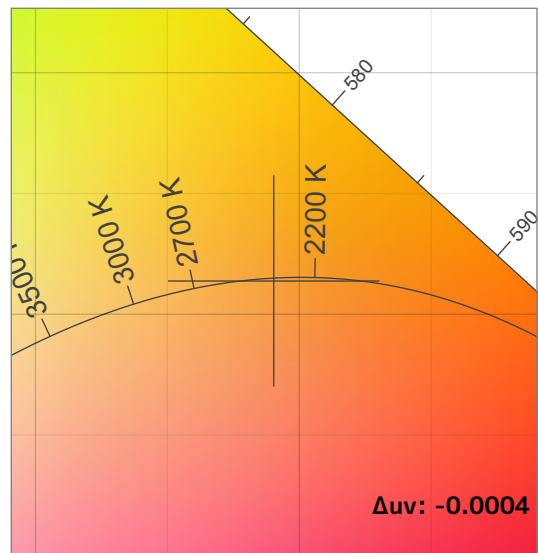

**CRI: 78.6 (R1-R8)**

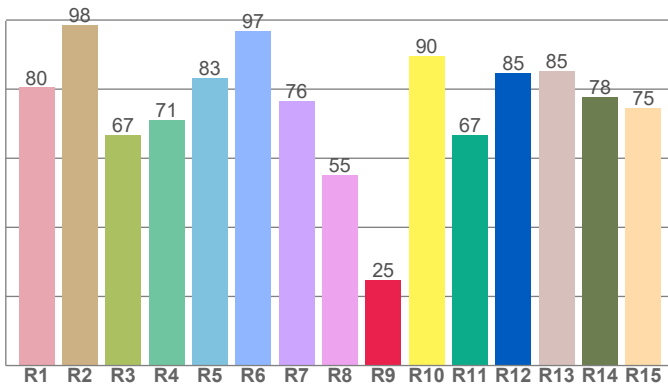

**Spectral Power Distribution (SPD)**

Dominant Wavelength 587 nm

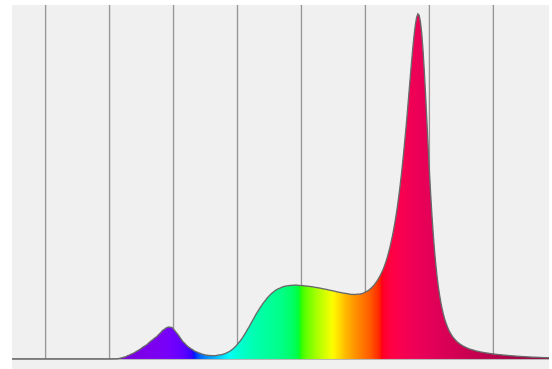

**SSI Spectral Variance Graph- Tungsten**

SSI [CIE A] 48

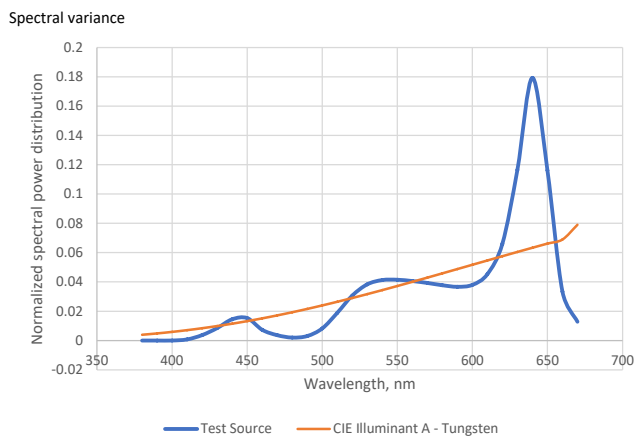

**SSI Spectral Variance Graph- Daylight**

SSI [CIE D65] -11

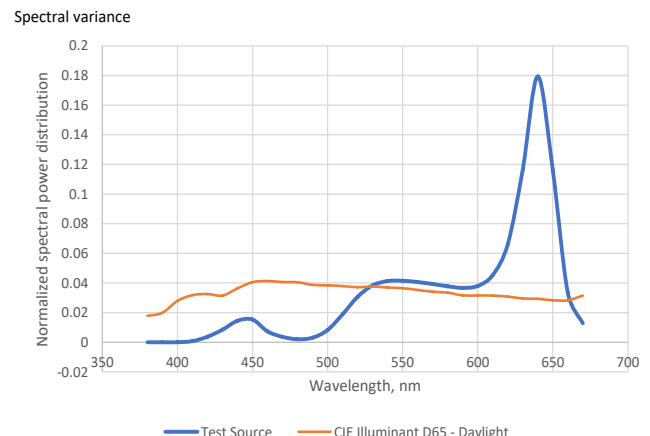

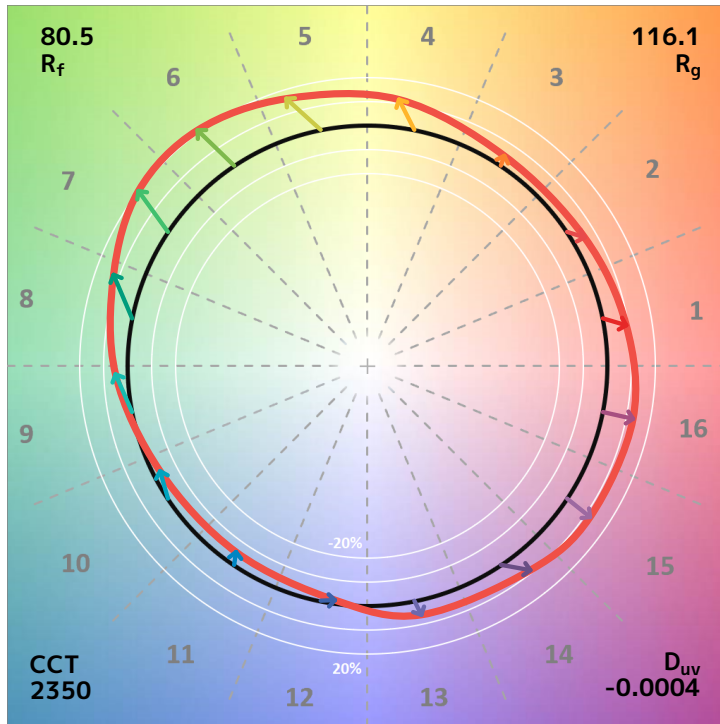

TM30-18 R<sub>f</sub> Values per Hue Bin

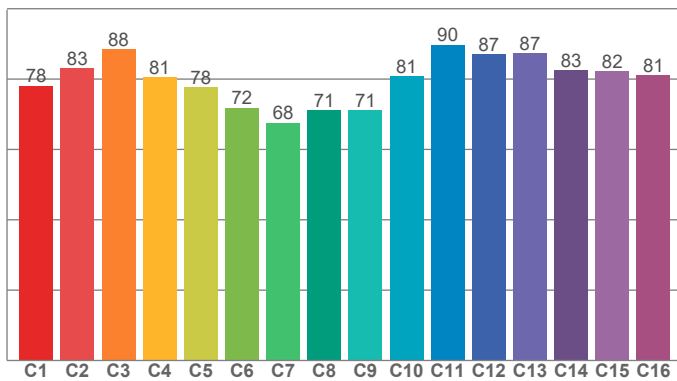

TM30 Chroma Shift per Hue Bin

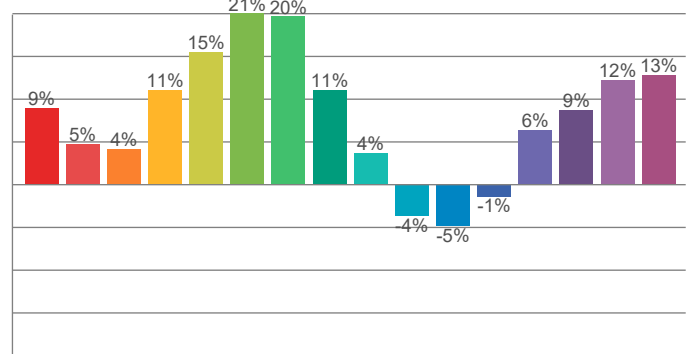

TM30-18 R<sub>f</sub> Values per Reference Color (CES)

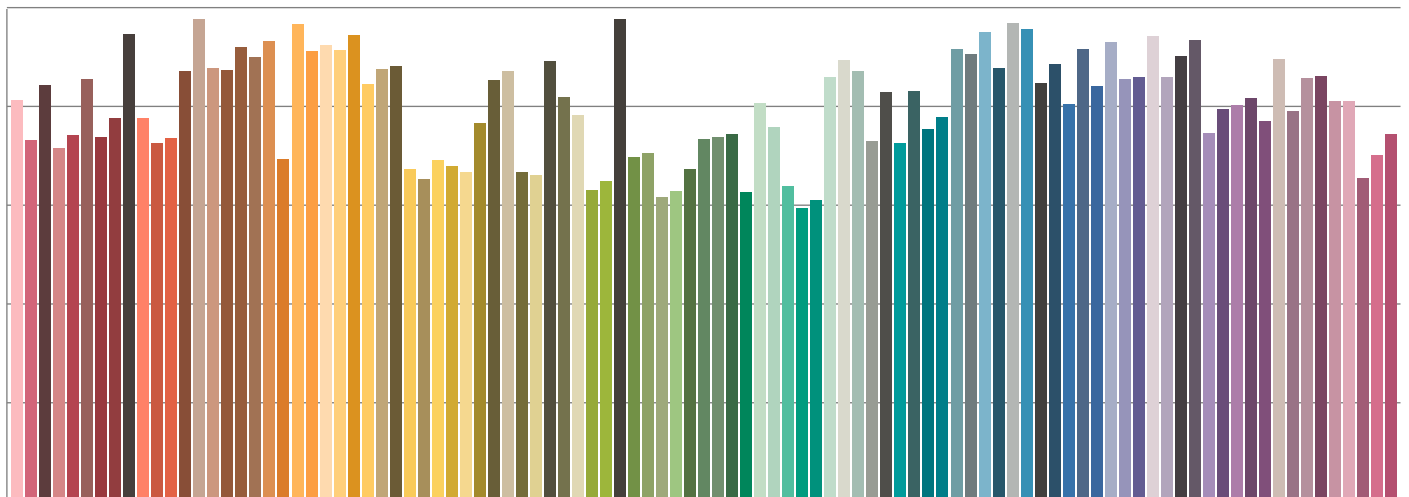

### Color Temperature: 3176K

#### Accuracy Metric Overview

Color Rendering Index	Color Rendering Index, R9 (Red Component)	TM-30 Color Fidelity	TM-30 Color Gamut	Television Lighting Consistency Index	Color Quality Scale	Color Coordinate- CIE 1931	Color Coordinate- CIE 1931	Deviation from Black Body Locus	SSI [CIE A] Tungsten	SSI [CIE D65] Daylight
CRI	CRI R9	TM30 R <sub>f</sub>	TM30 R <sub>g</sub>	TLCI	CQS	x	Y	$\Delta uv$	SSIt	SSId
82.8	96.5	84.6	103.1	74	83.1	0.443	0.439	0.0125	61	22

#### CIE 1931

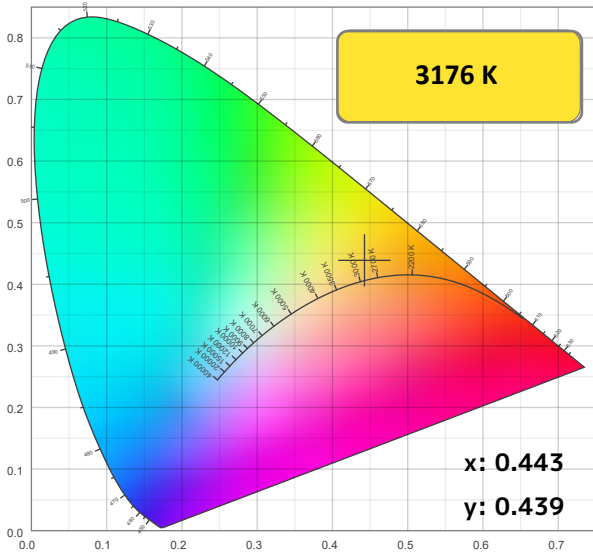

#### CIE 1931 ZOOMED

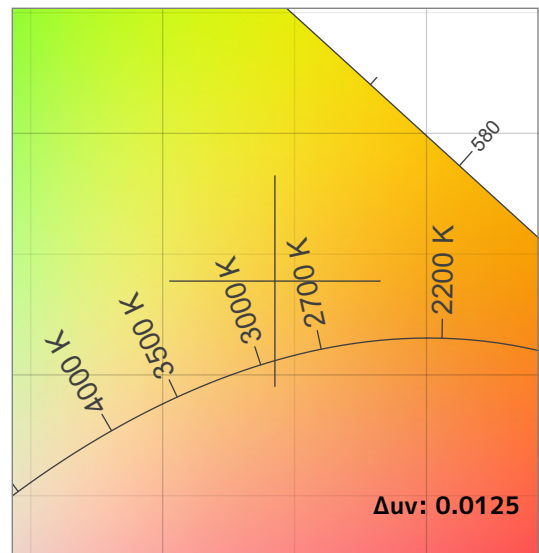

#### CRI: 82.8 (R1-R8)

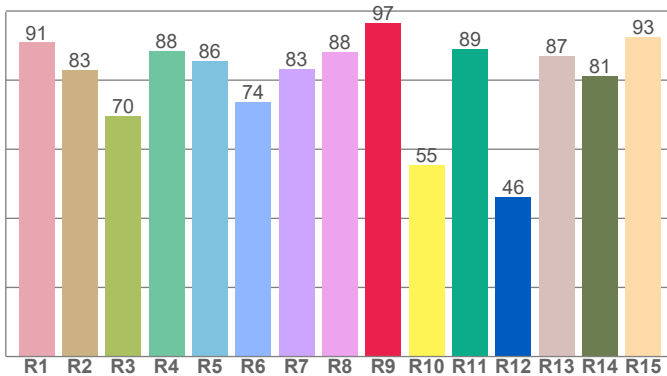

#### Spectral Power Distribution (SPD)

Dominant Wavelength 579 nm

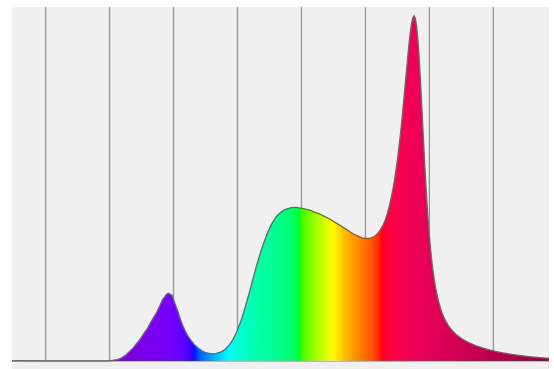

#### SSI Spectral Variance Graph- Tungsten

SSI [CIE A] 61

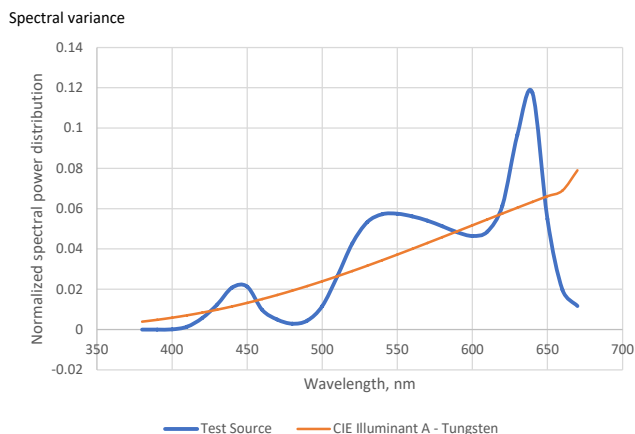

#### SSI Spectral Variance Graph- Daylight

SSI [CIE D65] 22

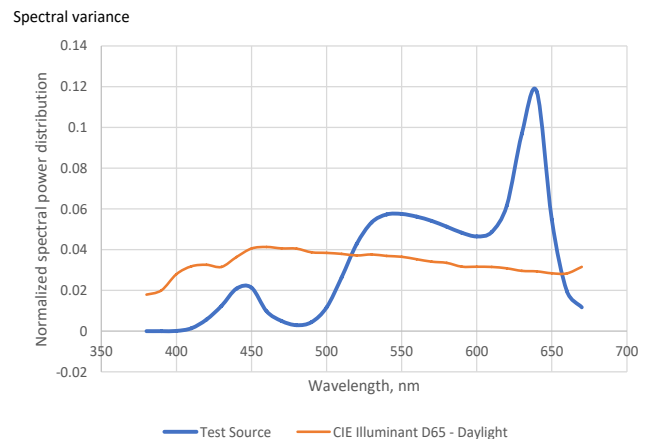

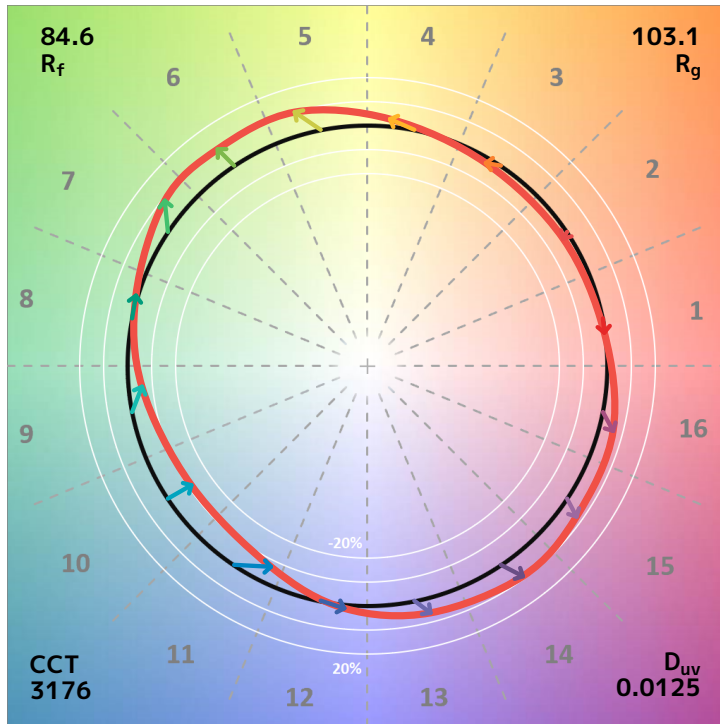

TM30-18  $R_f$  Values per Hue Bin

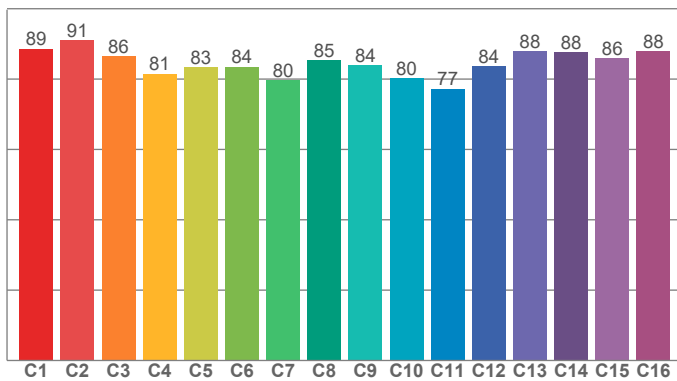

TM30 Chroma Shift per Hue Bin

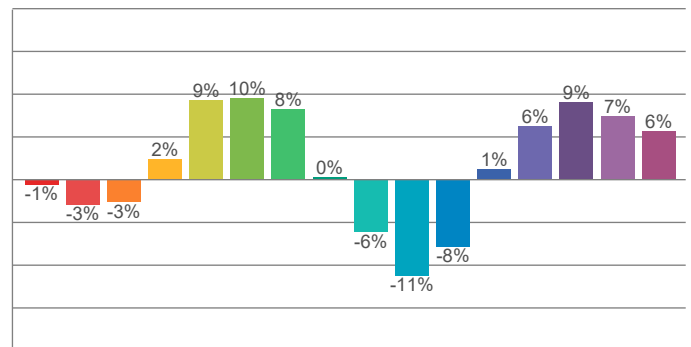

TM30-18  $R_f$  Values per Reference Color (CES)

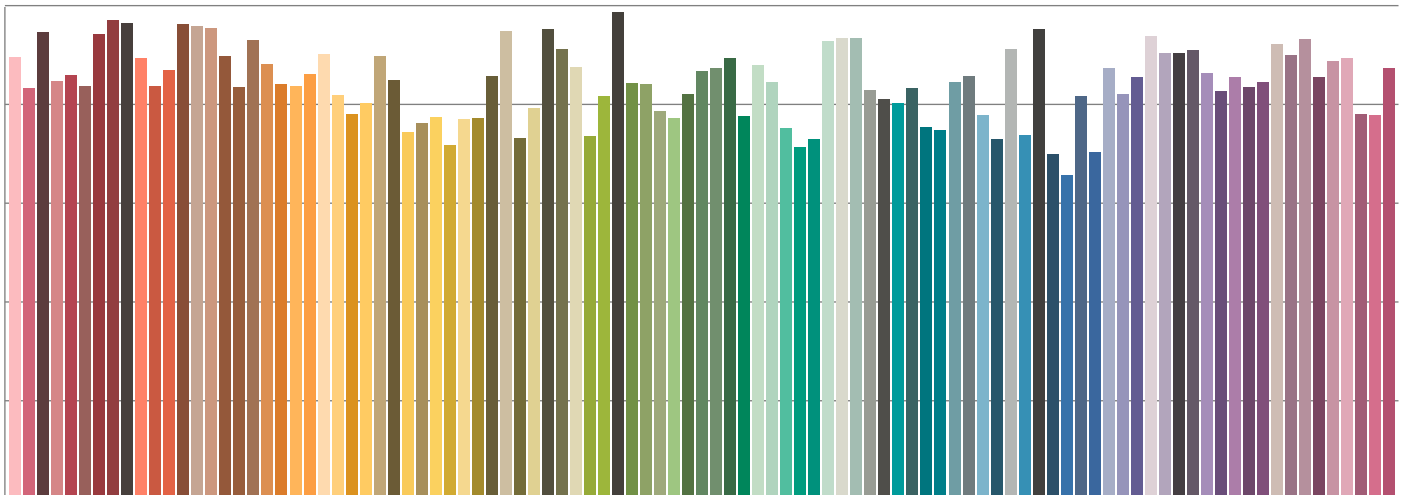

### Color Temperature: 4519K

#### Accuracy Metric Overview

Color Rendering Index	Color Rendering Index, R9 (Red Component)	TM-30 Color Fidelity	TM-30 Color Gamut	Television Lighting Consistency Index	Color Quality Scale	Color Coordinate-CIE 1931	Color Coordinate-CIE 1931	Deviation from Black Body Locus	SSI [CIE A] Tungsten	SSI [CIE D65] Daylight
CRI	CRI R9	TM30 R <sub>f</sub>	TM30 R <sub>g</sub>	TLCI	CQS	x	Y	Δuv	SSIt	SSId
73.9	24.5	75.6	98.9	61	77.5	0.365	0.388	0.0100	43	49

#### CIE 1931

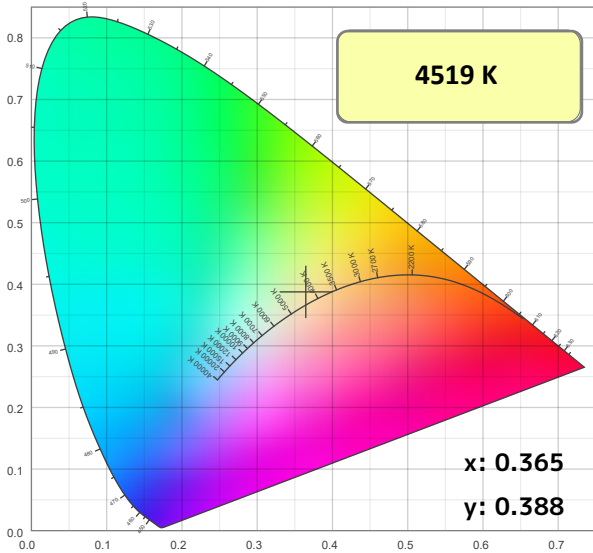

#### CIE 1931 ZOOMED

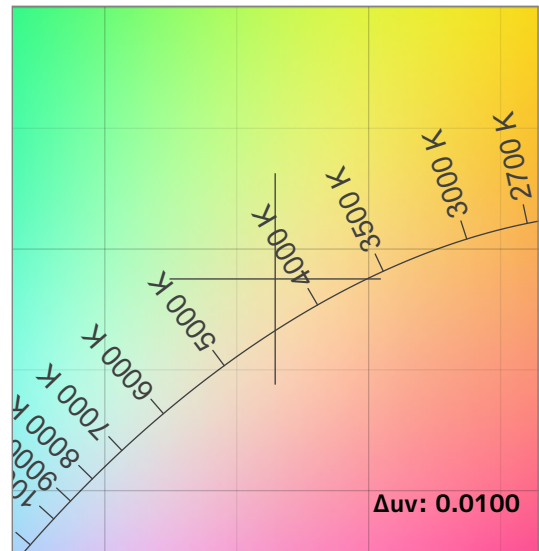

#### CRI: 73.9 (R1-R8)

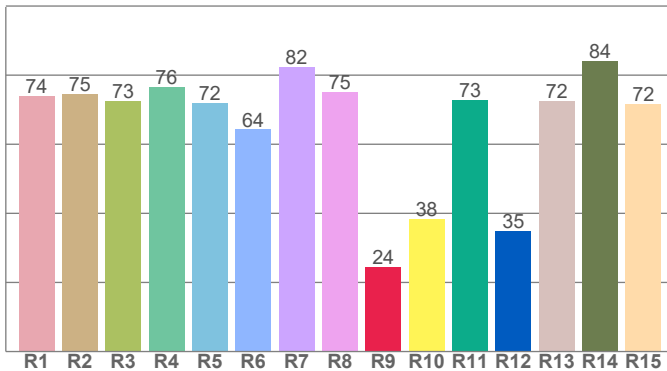

#### Spectral Power Distribution (SPD)

Dominant Wavelength 575 nm

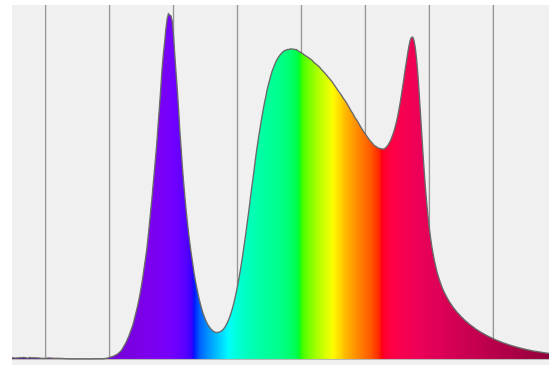

#### SSI Spectral Variance Graph- Tungsten

SSI [CIE A] 43

Spectral variance

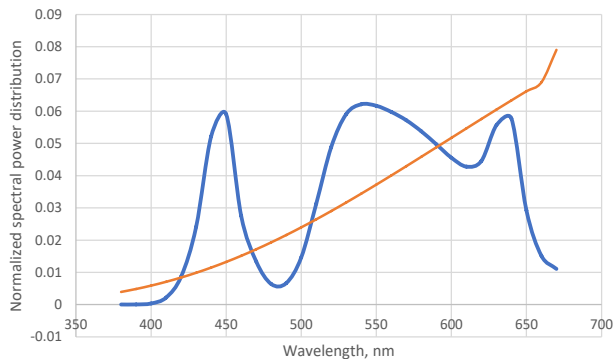

#### SSI Spectral Variance Graph- Daylight

SSI [CIE D65] 49

Spectral variance

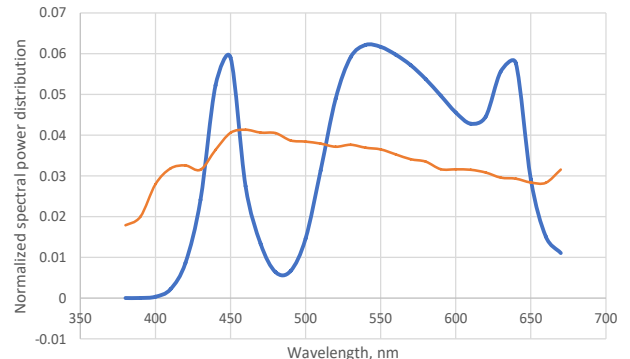

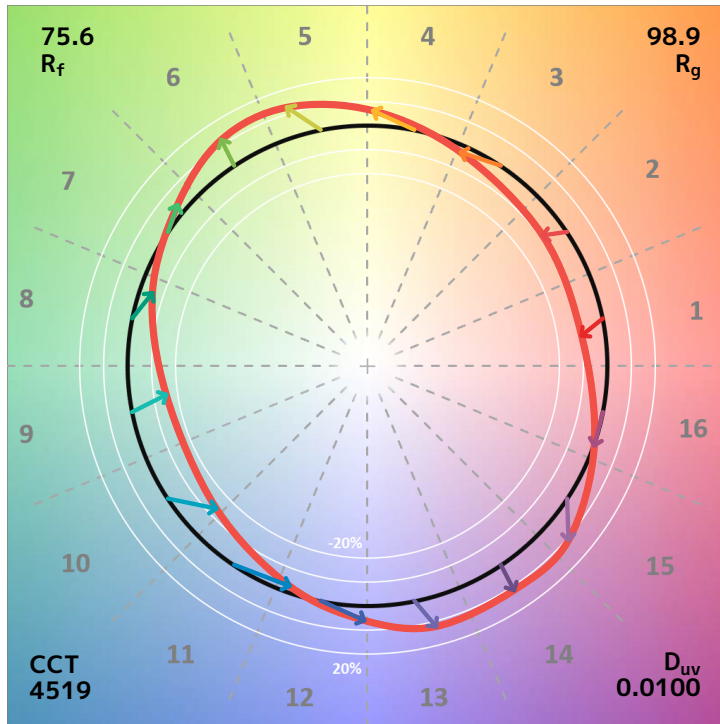

TM30-18 R<sub>f</sub> Values per Hue Bin

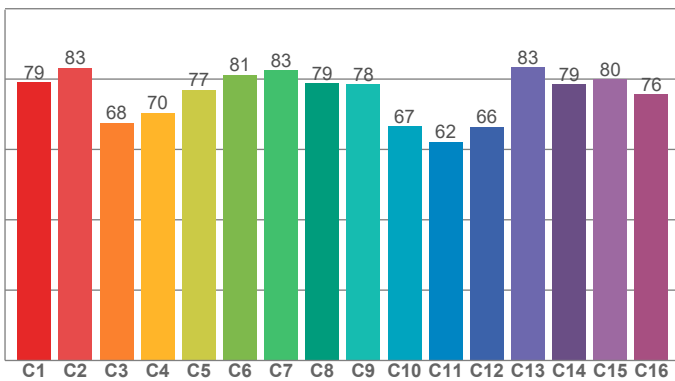

TM30 Chroma Shift per Hue Bin

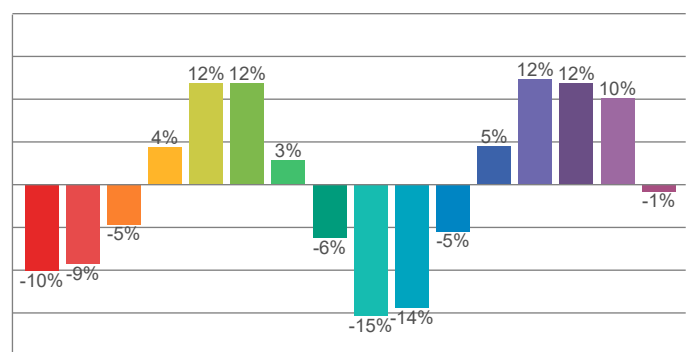

TM30-18 R<sub>f</sub> Values per Reference Color (CES)

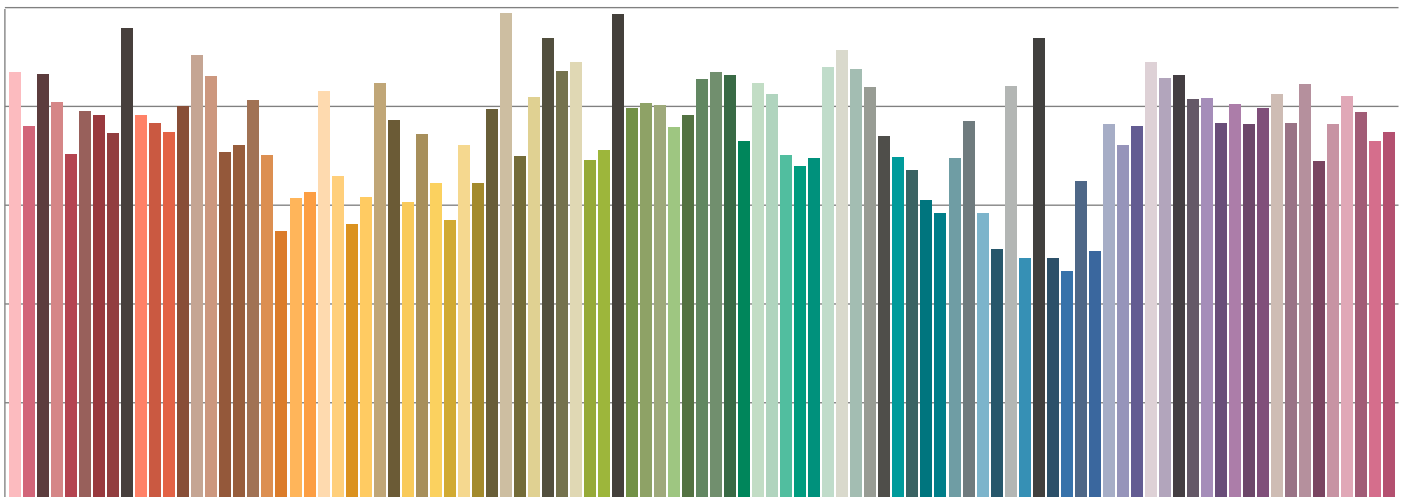

### Color Temperature: 5682K

#### Accuracy Metric Overview

Color Rendering Index	Color Rendering Index, R9 (Red Component)	TM-30 Color Fidelity	TM-30 Color Gamut	Television Lighting Consistency Index	Color Quality Scale	Color Coordinate- CIE 1931	Color Coordinate- CIE 1931	Deviation from Black Body Locus	SSI [CIE A] Tungsten	SSI [CIE D65] Daylight
CRI	CRI R9	TM30 R <sub>f</sub>	TM30 R <sub>g</sub>	TLCI	CQS	x	Y	Δuv	SSIt	SSId
74.4	19.1	75.8	99.2	66	77.3	0.328	0.356	0.0061	24	52

#### CIE 1931

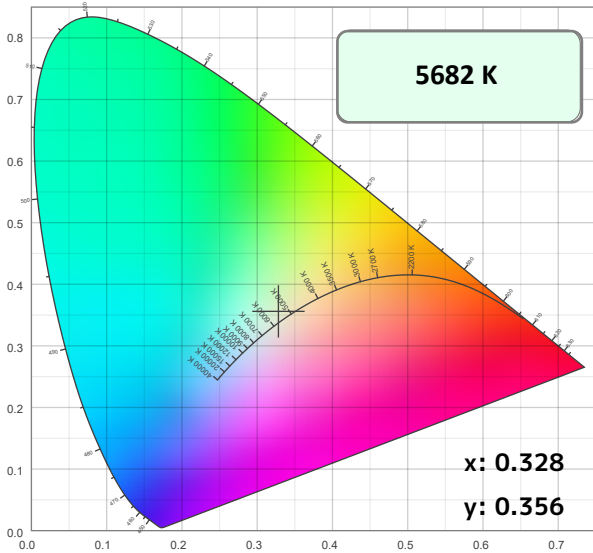

#### CIE 1931 ZOOMED

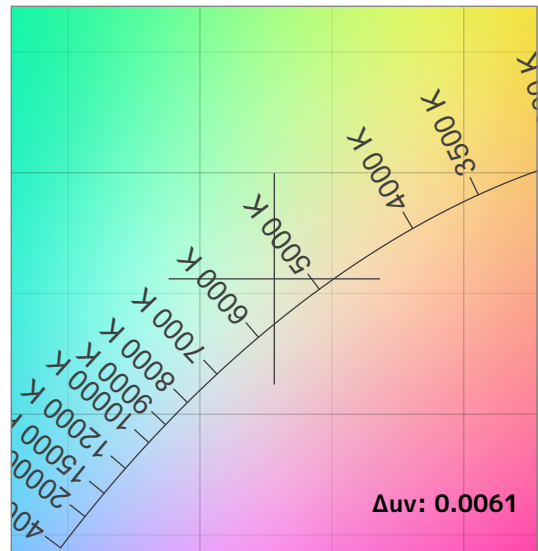

#### CRI: 74.4 (R1-R8)

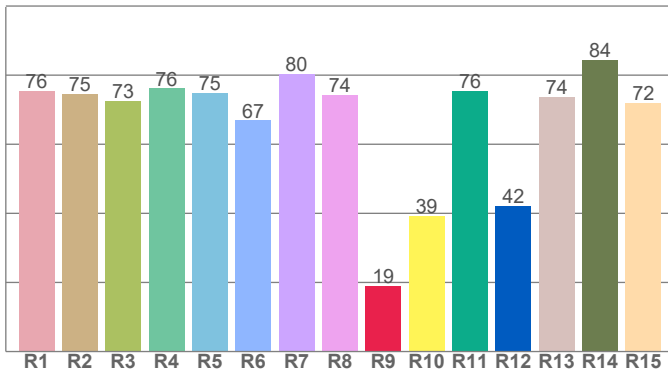

#### Spectral Power Distribution (SPD)

Dominant Wavelength 570 nm

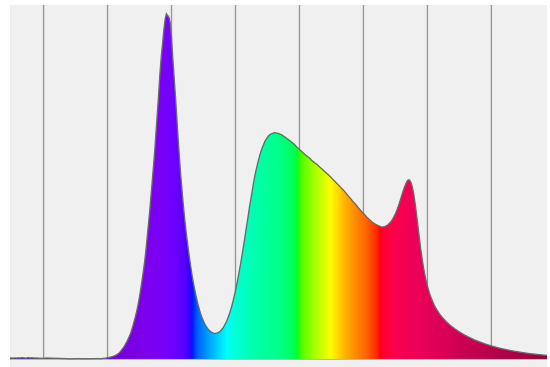

#### SSI Spectral Variance Graph- Tungsten

SSI [CIE A] 24

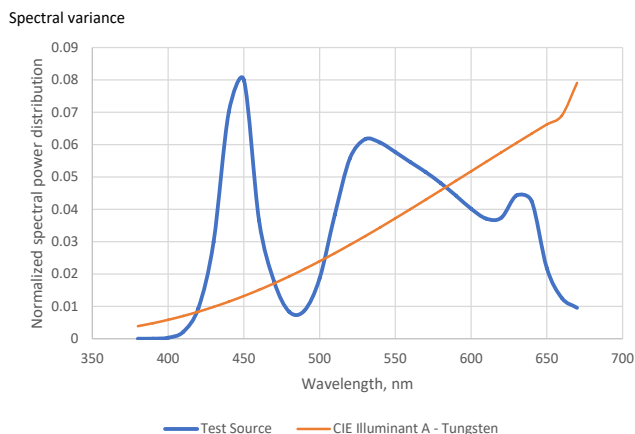

#### SSI Spectral Variance Graph- Daylight

SSI [CIE D65] 52

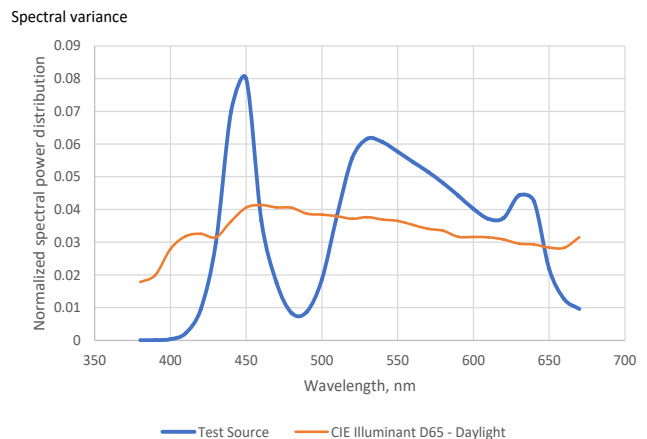

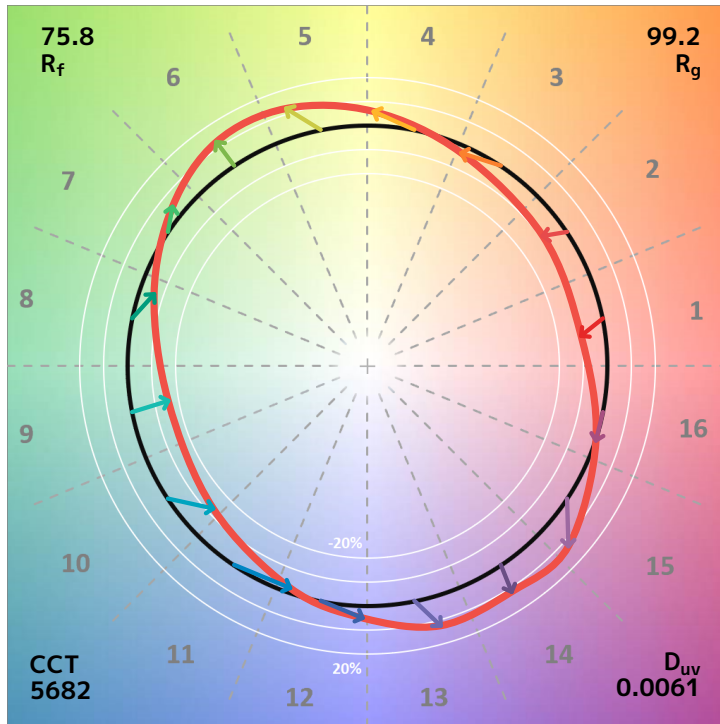

TM30-18  $R_f$  Values per Hue Bin

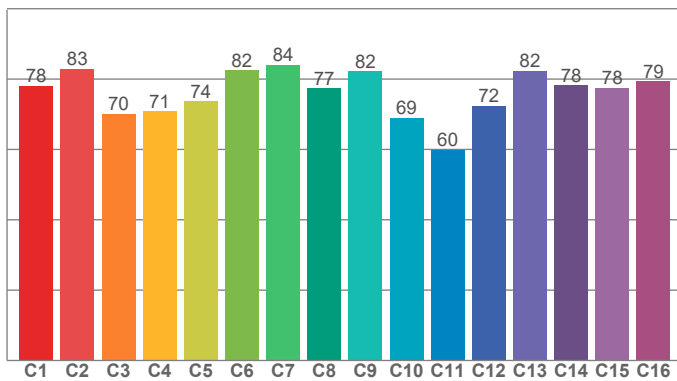

TM30 Chroma Shift per Hue Bin

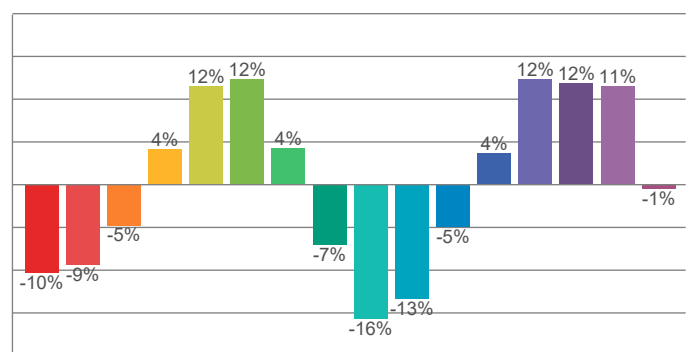

TM30-18  $R_f$  Values per Reference Color (CES)

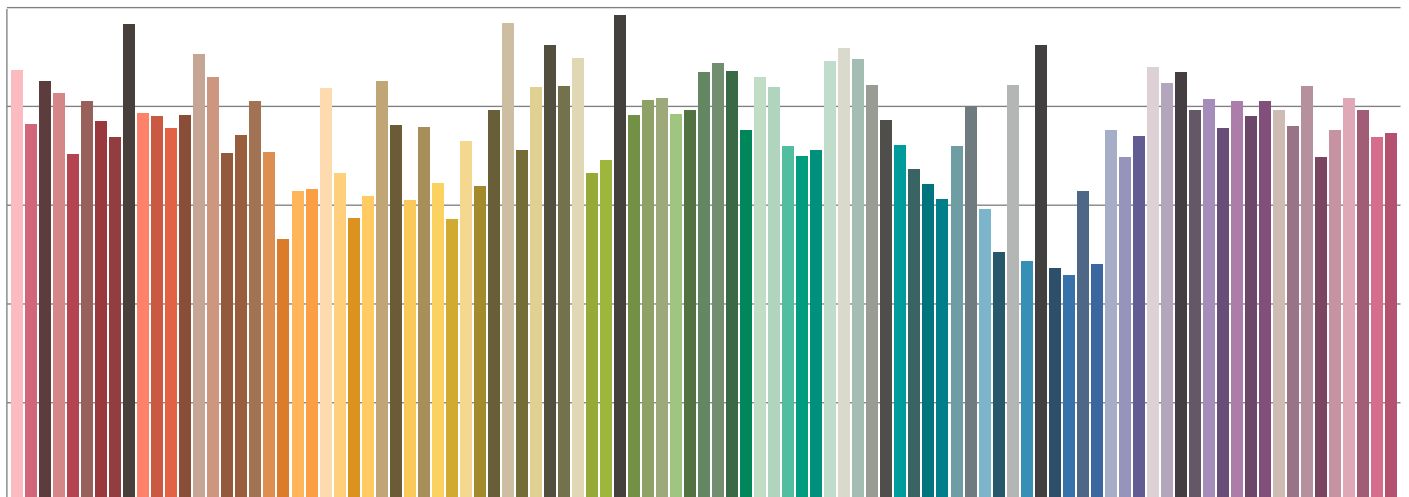

### Color Temperature: 6510K

#### Accuracy Metric Overview

Color Rendering Index	Color Rendering Index, R9 (Red Component)	TM-30 Color Fidelity	TM-30 Color Gamut	Television Lighting Consistency Index	Color Quality Scale	Color Coordinate- CIE 1931	Color Coordinate- CIE 1931	Deviation from Black Body Locus	SSI [CIE A] Tungsten	SSI [CIE D65] Daylight
CRI	CRI R9	TM30 R <sub>f</sub>	TM30 R <sub>g</sub>	TLCI	CQS	x	Y	Δuv	SSIt	SSId
75.3	23.6	76.4	98.9	69	78.0	0.312	0.338	0.0049	15	51

#### CIE 1931

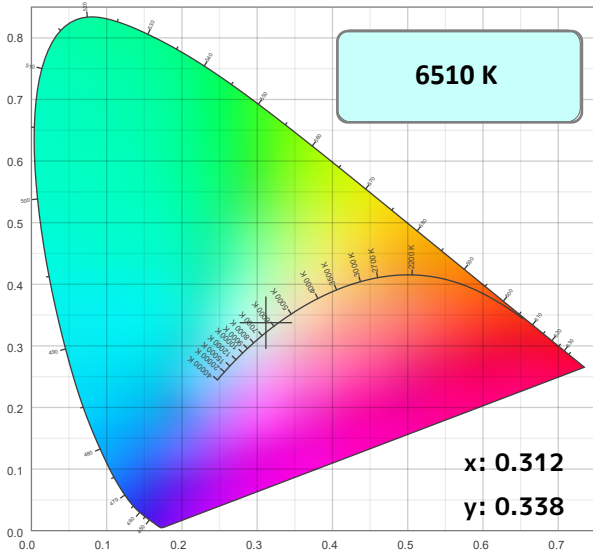

#### CIE 1931 ZOOMED

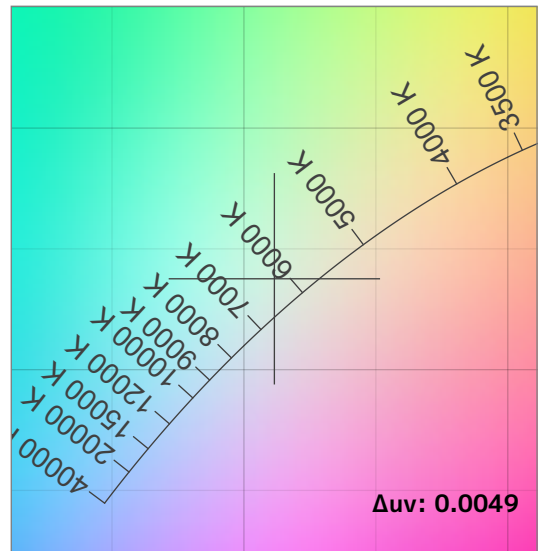

#### CRI: 75.3 (R1-R8)

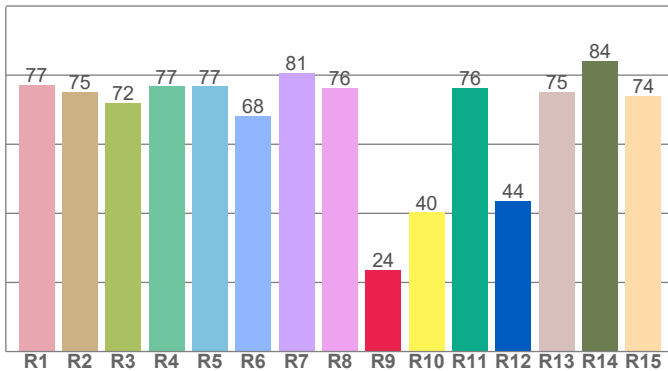

#### Spectral Power Distribution (SPD)

Dominant Wavelength 544 nm

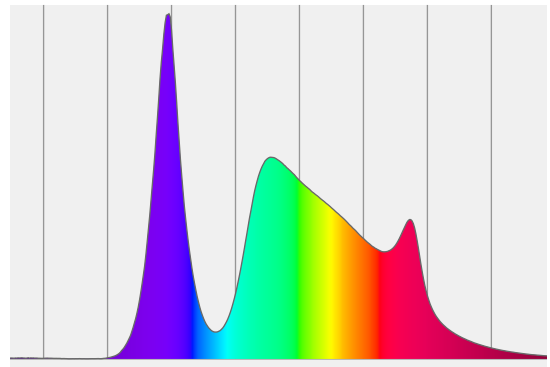

#### SSI Spectral Variance Graph- Tungsten

SSI [CIE A] 15

Spectral variance

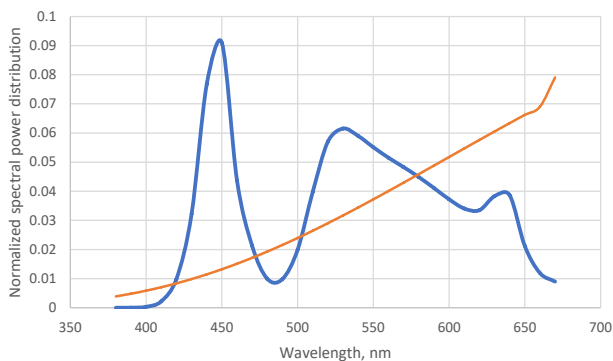

— Test Source — CIE Illuminant A - Tungsten

#### SSI Spectral Variance Graph- Daylight

SSI [CIE D65] 51

Spectral variance

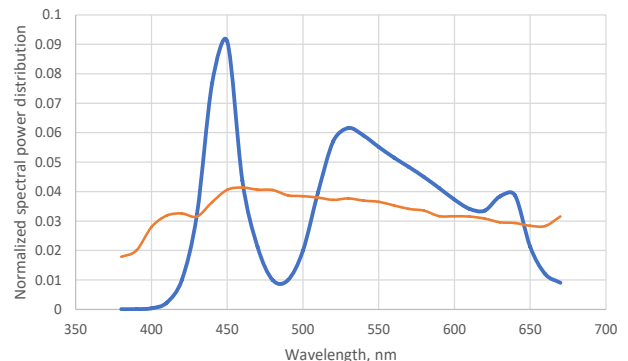

— Test Source — CIE Illuminant D65 - Daylight

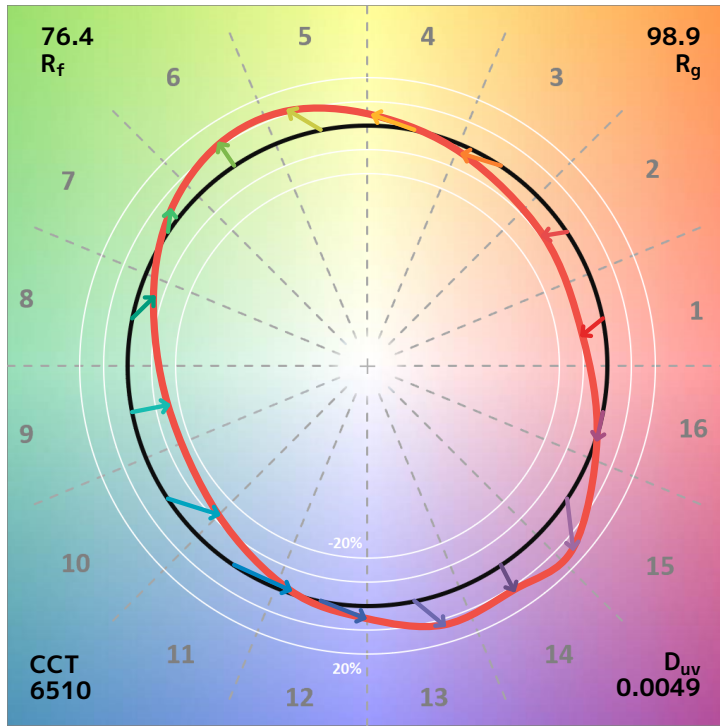

TM30-18 R<sub>f</sub> Values per Hue Bin

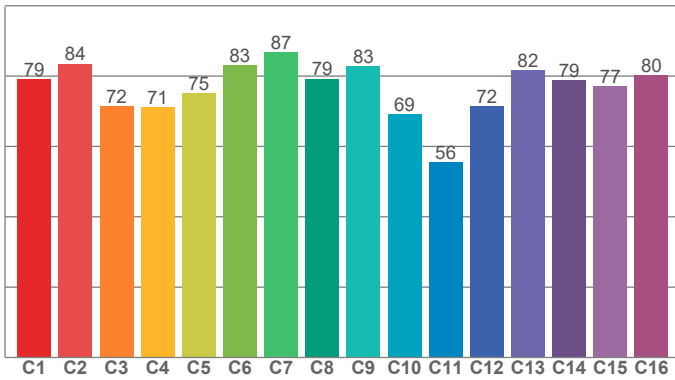

TM30 Chroma Shift per Hue Bin

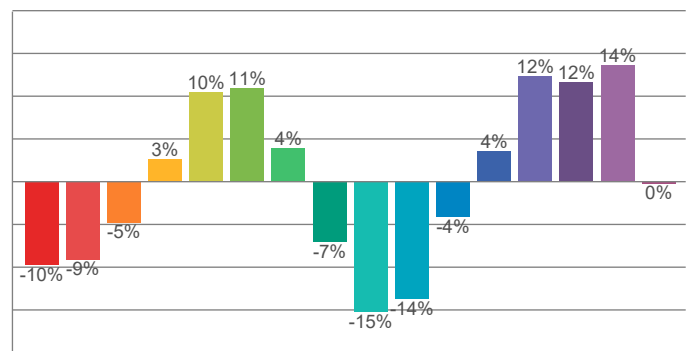

TM30-18 R<sub>f</sub> Values per Reference Color (CES)

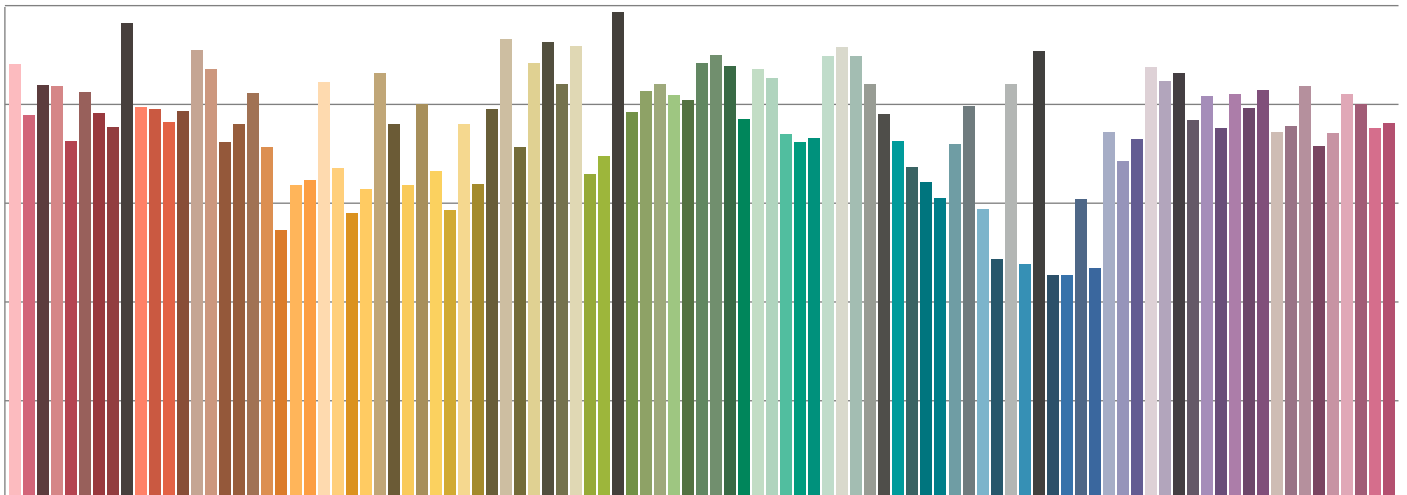

### Color Temperature: 8568K

#### Accuracy Metric Overview

Color Rendering Index	Color Rendering Index, R9 (Red Component)	TM-30 Color Fidelity	TM-30 Color Gamut	Television Lighting Consistency Index	Color Quality Scale	Color Coordinate-CIE 1931	Color Coordinate-CIE 1931	Deviation from Black Body Locus	SSI [CIE A] Tungsten	SSI [CIE D65] Daylight
CRI	CRI R9	TM30 R <sub>f</sub>	TM30 R <sub>g</sub>	TLCI	CQS	x	Y	Δuv	SSIt	SSId
75.9	25.9	76.3	98.4	69	78.3	0.287	0.308	0.0035	-1	47

#### CIE 1931

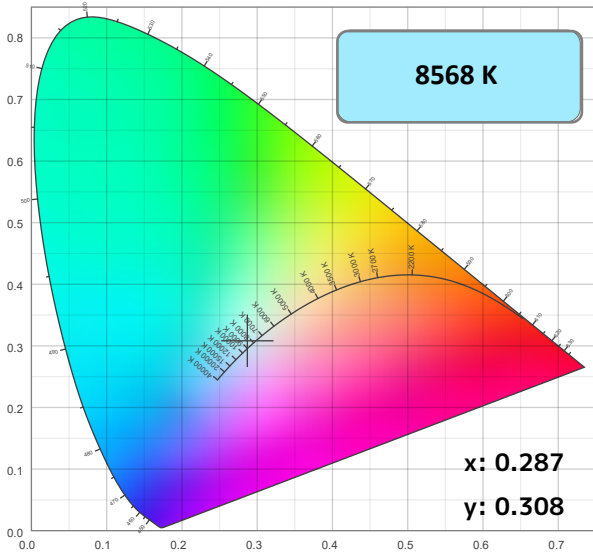

#### CIE 1931 ZOOMED

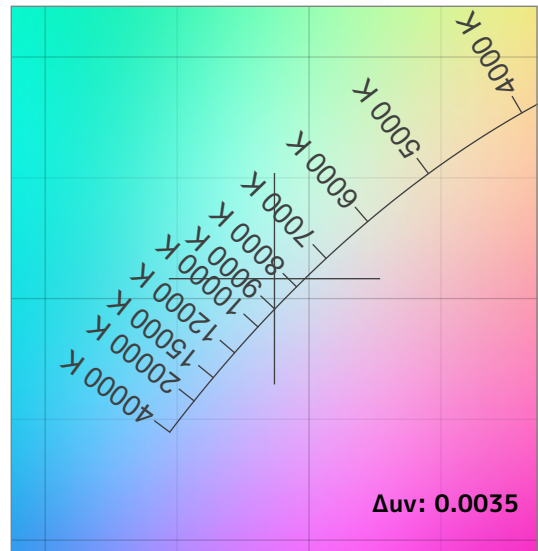

#### CRI: 75.9 (R1-R8)

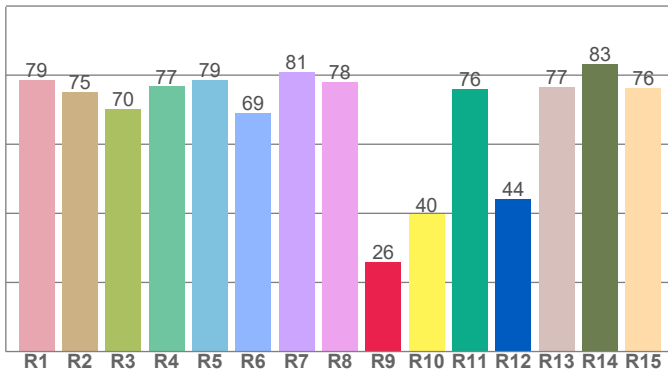

#### Spectral Power Distribution (SPD)

Dominant Wavelength 481 nm

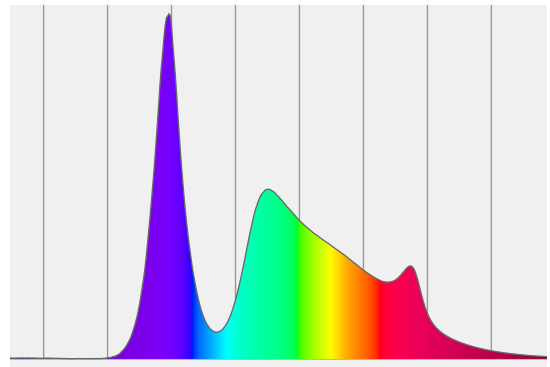

#### SSI Spectral Variance Graph- Tungsten

SSI [CIE A] -1

Spectral variance

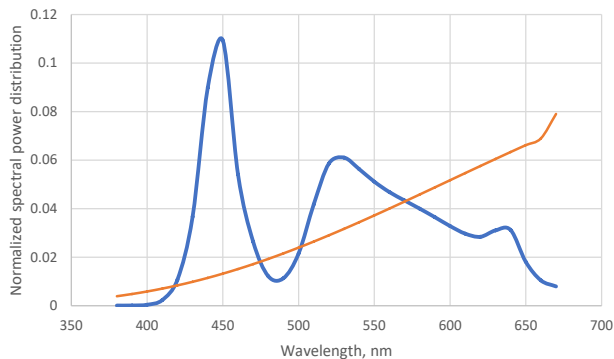

— Test Source — CIE Illuminant A - Tungsten

#### SSI Spectral Variance Graph- Daylight

SSI [CIE D65] 47

Spectral variance

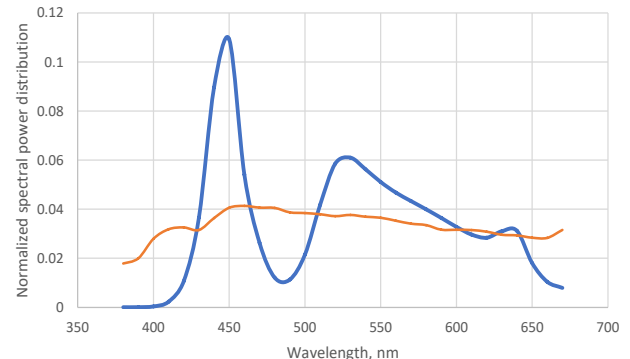

— Test Source — CIE Illuminant D65 - Daylight

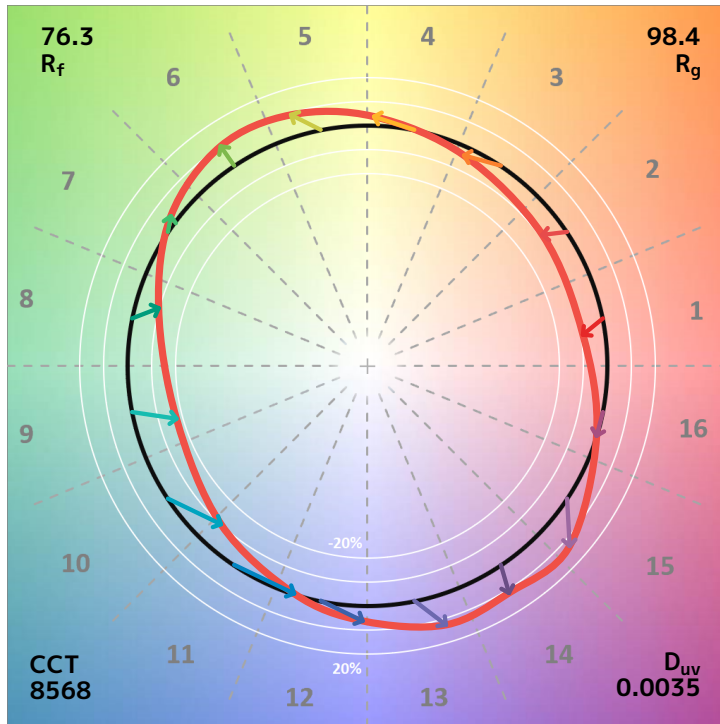

TM30-18 R<sub>f</sub> Values per Hue Bin

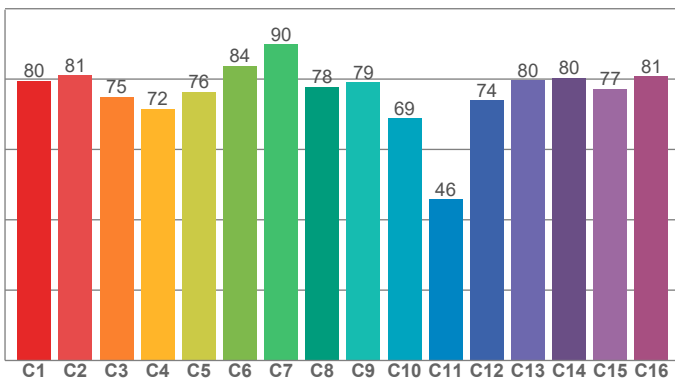

TM30 Chroma Shift per Hue Bin

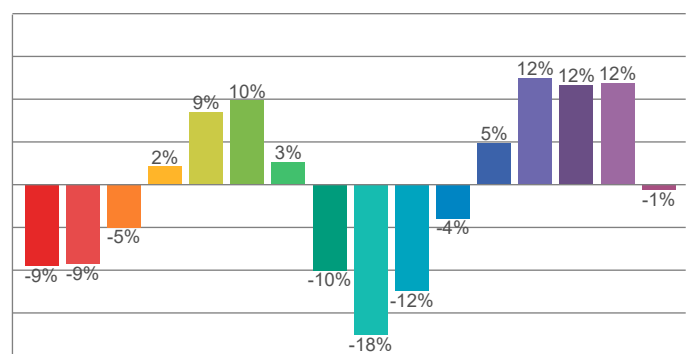

TM30-18 R<sub>f</sub> Values per Reference Color (CES)

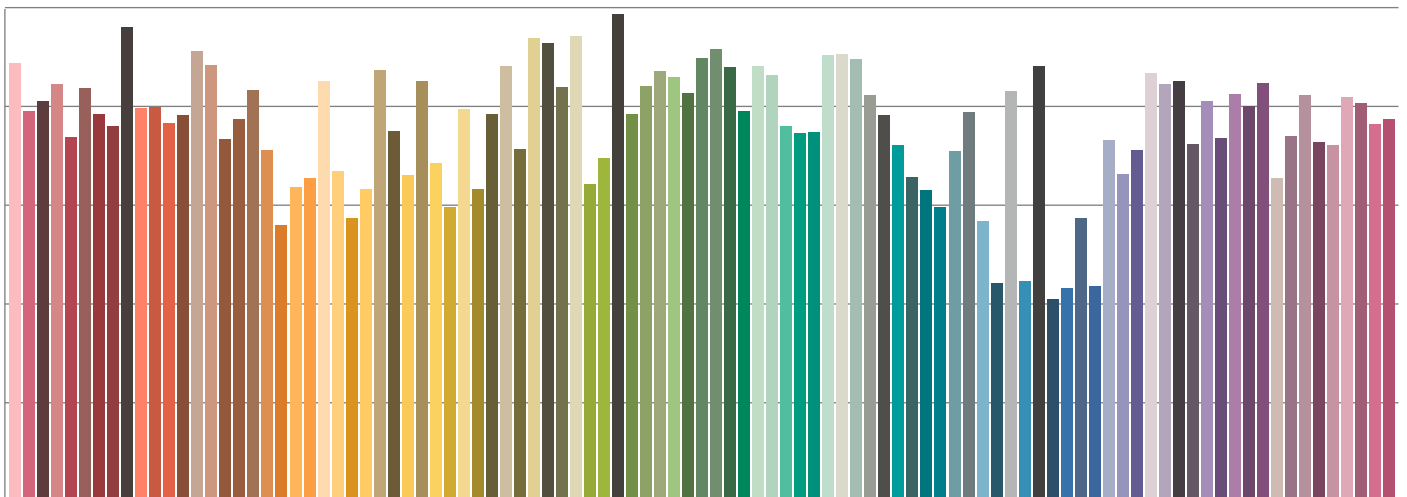

### Measurements

Total Lumen Output: 1034 lm

Peak Intensity: 9123 cd

Efficacy: 9 Lumen/Watt

Power: 121.5 W

Voltage: 120 V, Current: 1.04 A

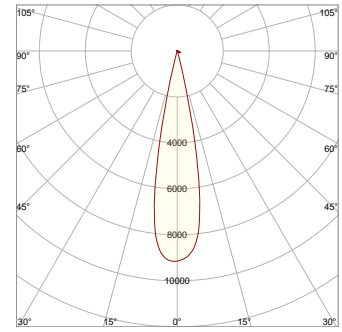
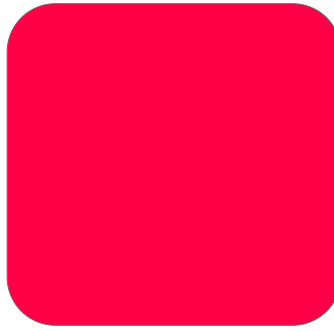

### Spectral Power Distribution Dominant Wavelength 624 nm

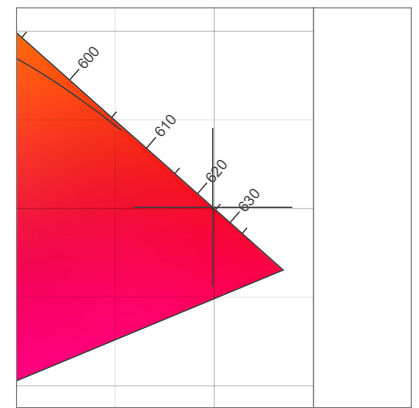
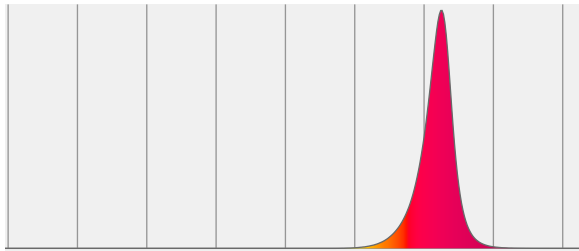

Dominant Wavelength	Color Coordinate CIE 1931	Color Coordinate CIE1931	Color Coordinate CIE 1964	Color Coordinate CIE 1964
nm	x	y	u	v
624	0.699	0.301	0.537	0.346

Distance	3 m	5 m	10 m	15 m	20 m
Beam Width	1.1 m	1.8 m	3.7 m	5.5 m	7.4 m

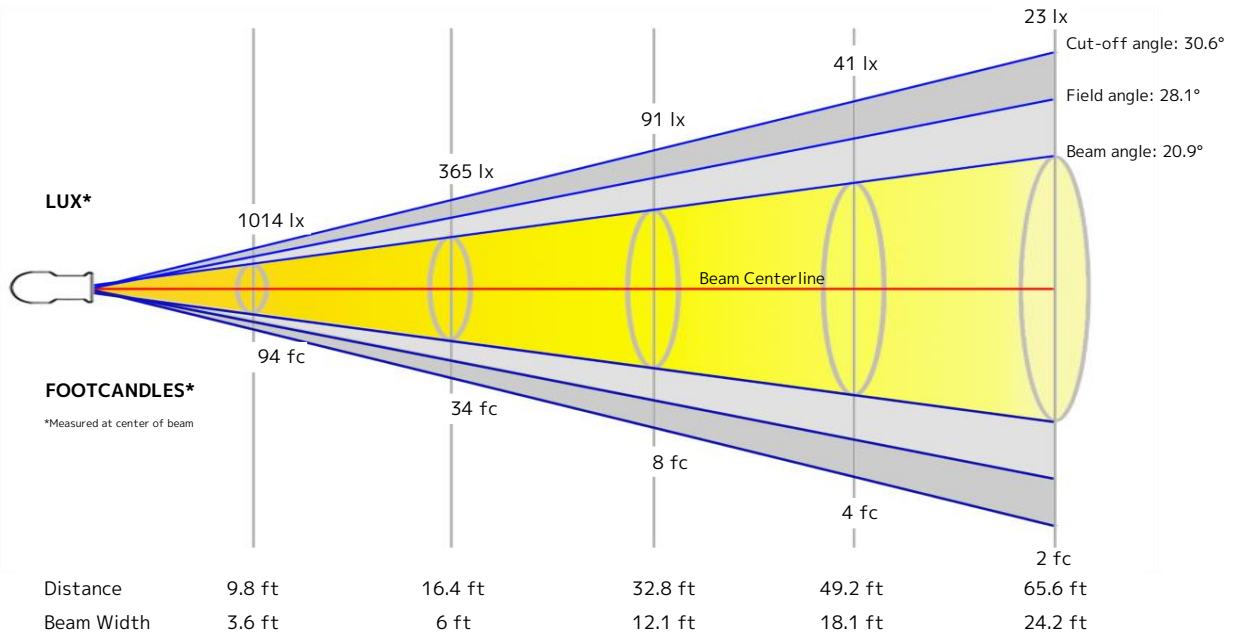

### Beam Intensities from 1-20m

M	1	2	3	4	5	6	7	8	9	10	11	12	13	14	15	16	17	18	19	20
FT	3.3	6.6	9.8	13.1	16.4	19.7	23	26.2	29.5	32.8	36.1	39.4	42.7	45.9	49.2	52.5	55.8	59.1	62.3	65.6
LX	9123	2281	1014	570	365	253	186	143	113	91	75	63	54	47	41	36	32	28	25	23
FC	847.6	211.9	94.2	53	33.9	23.5	17.3	13.2	10.5	8.5	7	5.9	5	4.3	3.8	3.3	2.9	2.6	2.3	2.1

### Measurements

Total Lumen Output: 2107 lm

Peak Intensity: 20434 cd

Efficacy: 16 Lumen/Watt

Power: 130.7 W

Voltage: 120 V, Current: 1.11 A

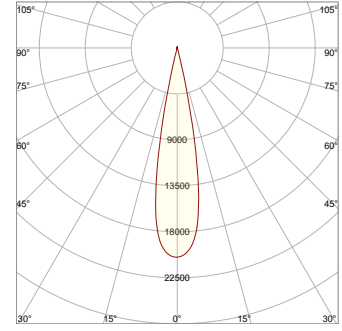
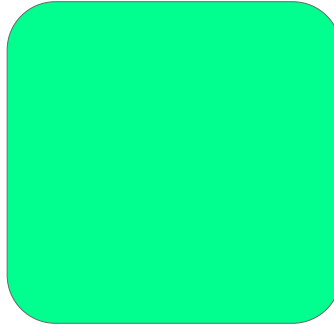

### Spectral Power Distribution Dominant Wavelength 525 nm

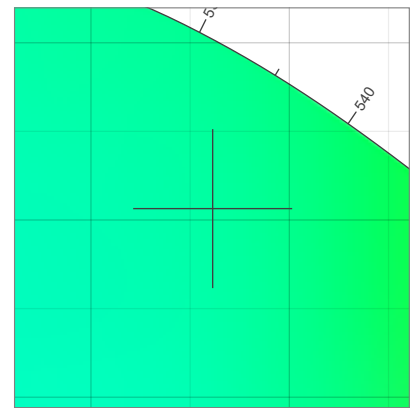
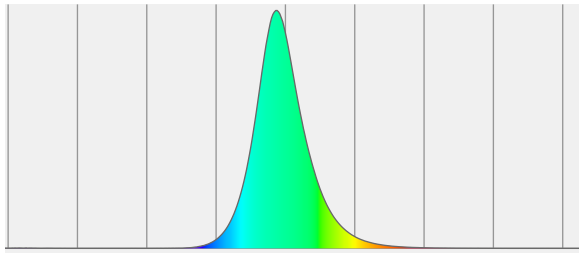

Dominant Wavelength	Color Coordinate CIE 1931	Color Coordinate CIE1931	Color Coordinate CIE 1964	Color Coordinate CIE 1964
nm	x	y	u	v
525	0.161	0.706	0.058	0.380

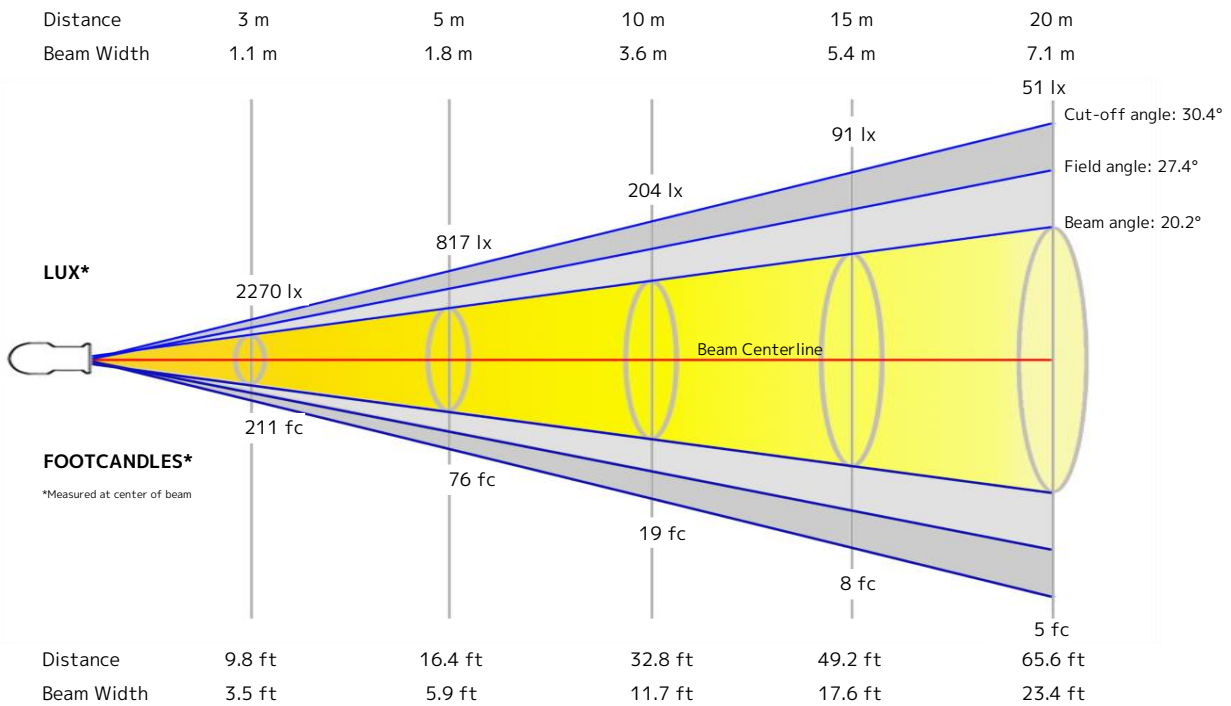

### Beam Intensities from 1-20m

M	1	2	3	4	5	6	7	8	9	10	11	12	13	14	15	16	17	18	19	20
FT	3.3	6.6	9.8	13.1	16.4	19.7	23	26.2	29.5	32.8	36.1	39.4	42.7	45.9	49.2	52.5	55.8	59.1	62.3	65.6
LX	20427	5107	2270	1277	817	567	417	319	252	204	169	142	121	104	91	80	71	63	57	51
FC	1897.7	474.4	210.9	118.6	75.9	52.7	38.7	29.7	23.4	19	15.7	13.2	11.2	9.7	8.4	7.4	6.6	5.9	5.3	4.7

### Measurements

Total Lumen Output: 474 lm

Peak Intensity: 4974 cd

Efficacy: 3 Lumen/Watt

Power: 139.6 W

Voltage: 119 V, Current: 1.19 A

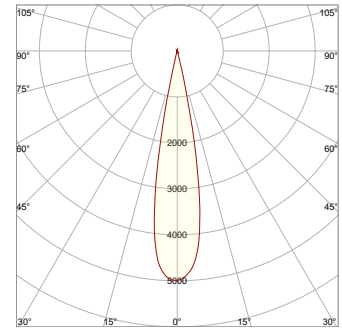
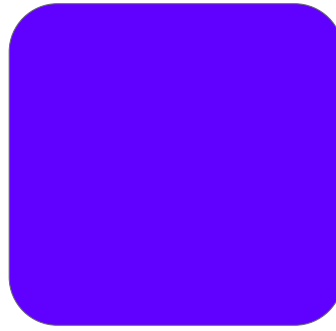

### Spectral Power Distribution Dominant Wavelength 452 nm

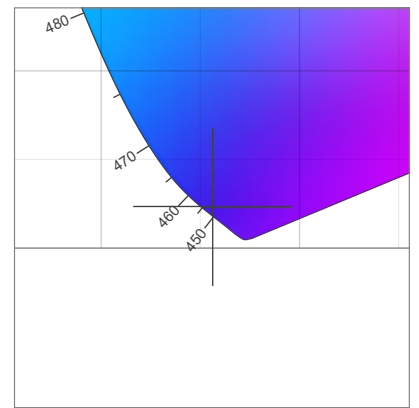
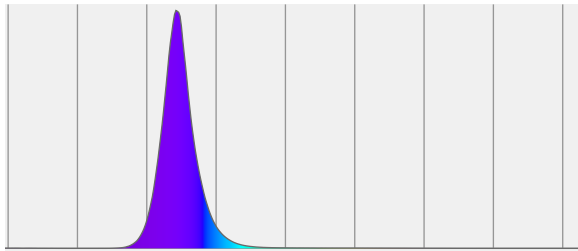

Dominant Wavelength	Color Coordinate CIE 1931	Color Coordinate CIE1931	Color Coordinate CIE 1964	Color Coordinate CIE 1964
nm	x	y	u	v
452	0.156	0.023	0.210	0.047

Distance	3 m	5 m	10 m	15 m	20 m
Beam Width	1 m	1.7 m	3.5 m	5.2 m	6.9 m

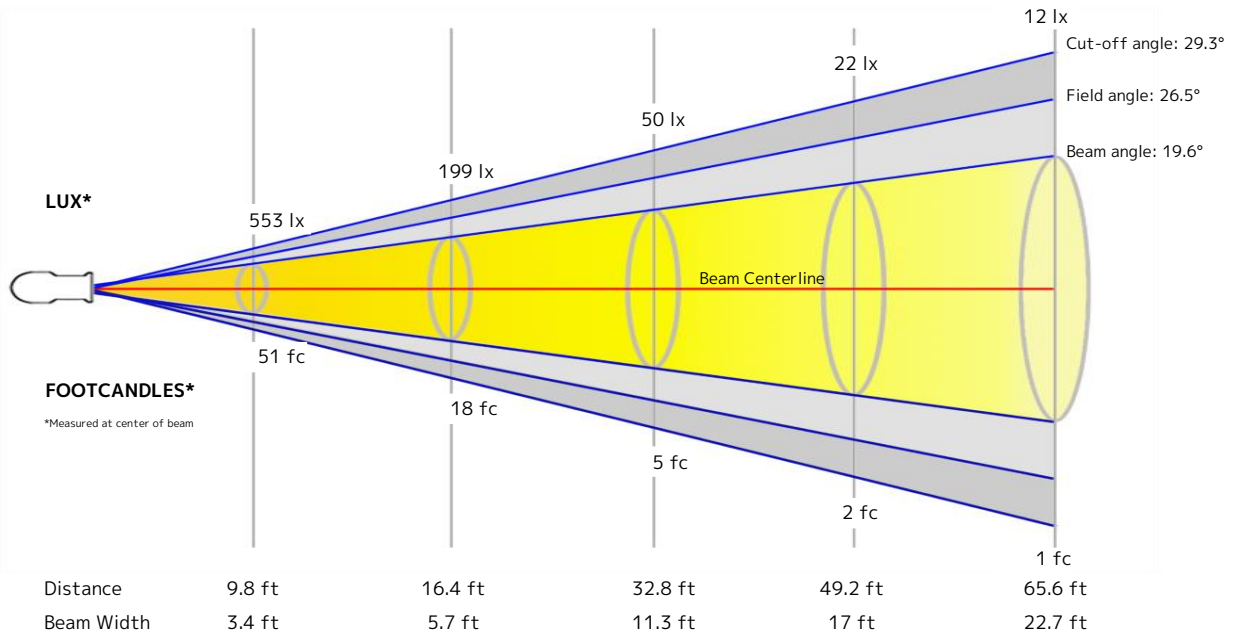

### Beam Intensities from 1-20m

M	1	2	3	4	5	6	7	8	9	10	11	12	13	14	15	16	17	18	19	20
FT	3.3	6.6	9.8	13.1	16.4	19.7	23	26.2	29.5	32.8	36.1	39.4	42.7	45.9	49.2	52.5	55.8	59.1	62.3	65.6
LX	4974	1244	553	311	199	138	102	78	61	50	41	35	29	25	22	19	17	15	14	12
FC	462.1	115.5	51.3	28.9	18.5	12.8	9.4	7.2	5.7	4.6	3.8	3.2	2.7	2.4	2.1	1.8	1.6	1.4	1.3	1.2

### Measurements

Total Lumen Output: 3217 lm

Peak Intensity: 30333 cd

Efficacy: 23 Lumen/Watt

Power: 139.3 W

Voltage: 119 V, Current: 1.20 A

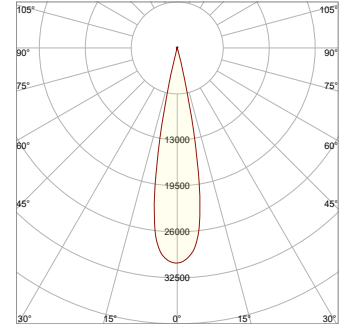
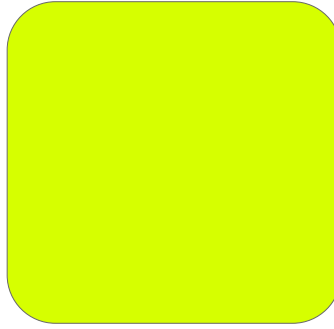

### Spectral Power Distribution Dominant Wavelength 569 nm

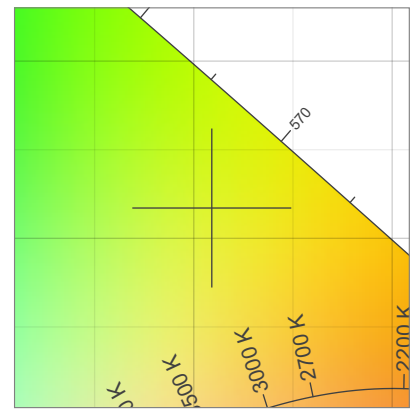
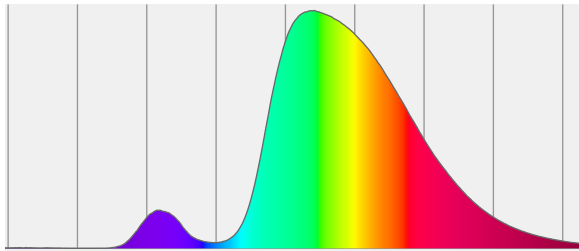

Dominant Wavelength	Color Coordinate CIE 1931	Color Coordinate CIE1931	Color Coordinate CIE 1964	Color Coordinate CIE 1964
nm	x	y	u	v
569	0.409	0.517	0.195	0.370

Distance	3 m	5 m	10 m	15 m	20 m
Beam Width	1.1 m	1.8 m	3.6 m	5.4 m	7.3 m

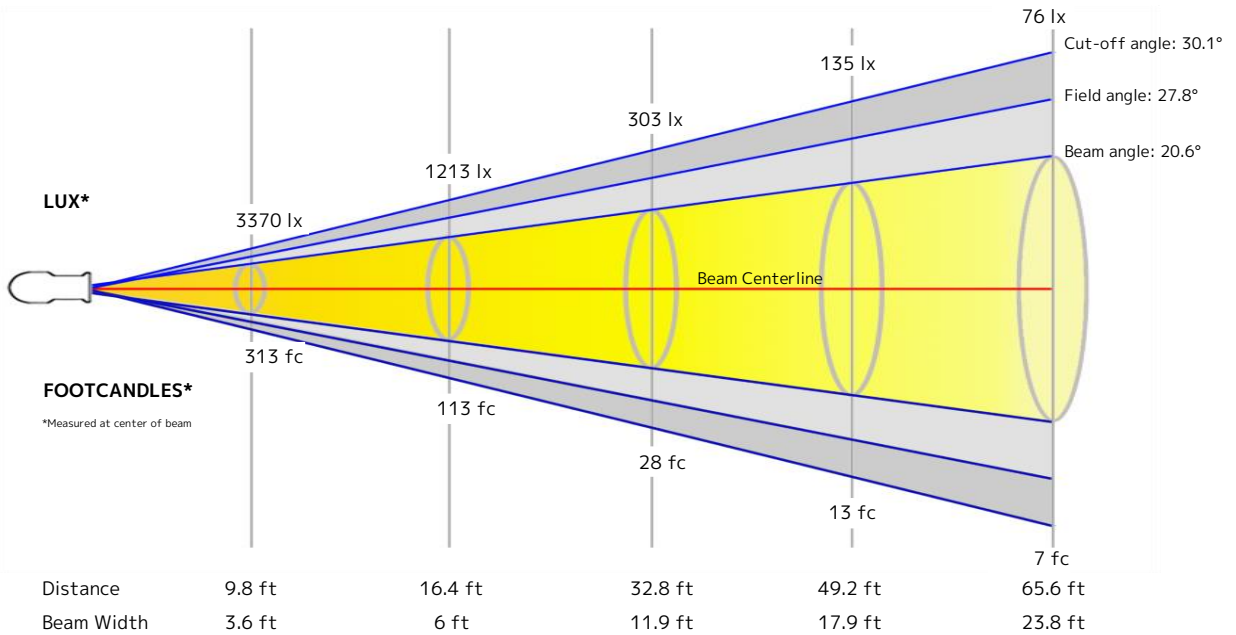

### Beam Intensities from 1-20m

M	1	2	3	4	5	6	7	8	9	10	11	12	13	14	15	16	17	18	19	20
FT	3.3	6.6	9.8	13.1	16.4	19.7	23	26.2	29.5	32.8	36.1	39.4	42.7	45.9	49.2	52.5	55.8	59.1	62.3	65.6
LX	30333	7583	3370	1896	1213	843	619	474	374	303	251	211	179	155	135	118	105	94	84	76
FC	2818.1	704.5	313.1	176.1	112.7	78.3	57.5	44	34.8	28.2	23.3	19.6	16.7	14.4	12.5	11	9.8	8.7	7.8	7